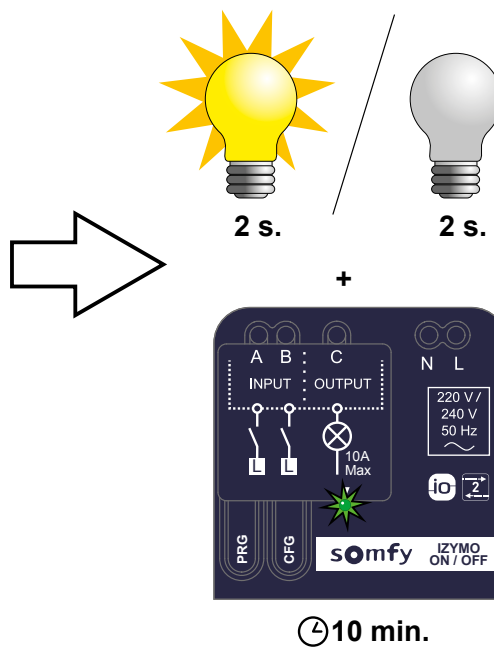
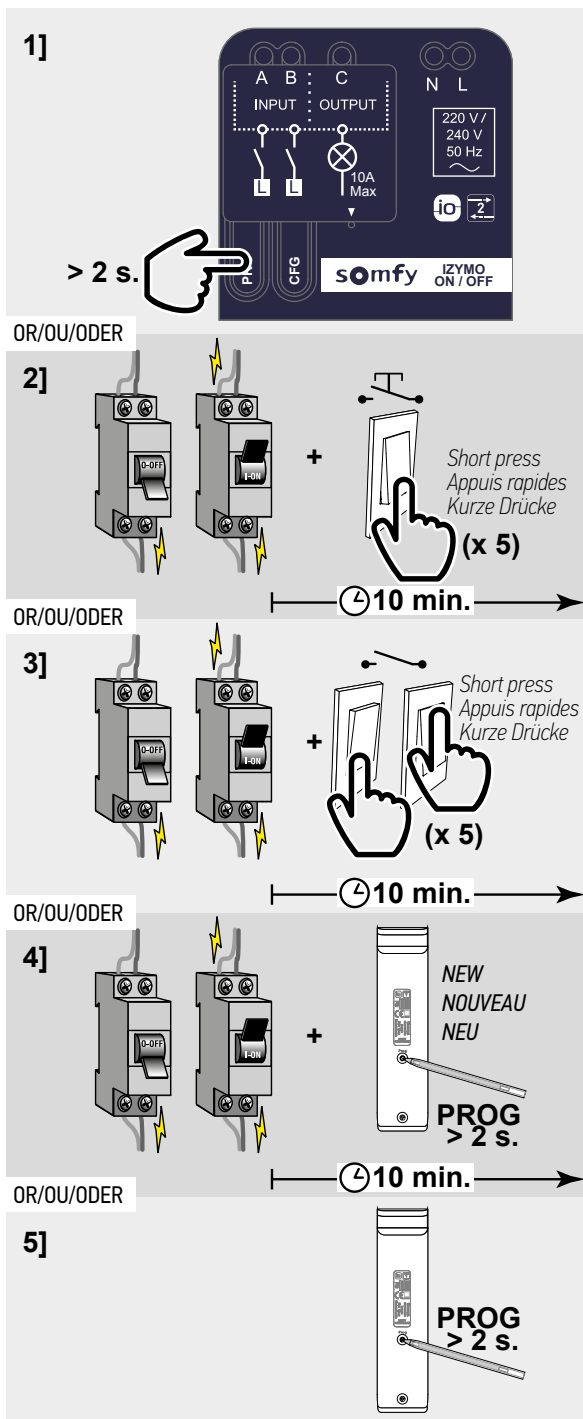
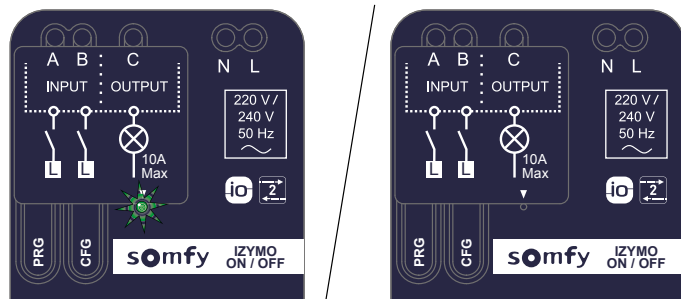
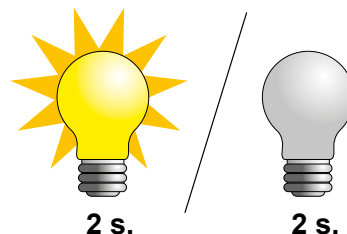
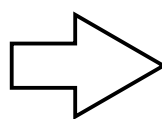
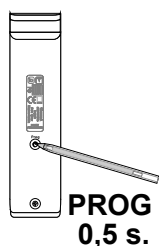

**A**

ASSOCIATING THE IZYO ON-OFF RECEIVER IO  
 METTRE EN MODE ASSOCIATION L'IZYO ON-OFF RECEIVER IO  
 ON-OFF RECEIVER IO IN DEN PROGRAMMIERMODUS SCHALTEN

**B**

ASSOCIATING OR DELETING AN IO-TRANSMITTER (A+B)  
 ASSOCIER OU SUPPRIMER UN EMETTEUR IO (A+B)  
 UNTERPUTZ-SENDER IO (A+B) HINZUFÜGEN ODER LÖSCHEN

**somfy**

SOMFY ACTIVITES SA

50, avenue du Nouveau Monde, F-74300 CLUSES

www.somfy.com

Somfy, dans un souci constant d'évolution et d'amélioration, peut modifier le produit sans préavis. Photos non contractuelles.

Copyright © 2018 SOMFY ACTIVITES SA, Société Anonyme. All rights reserved. Capital 35.000.000 Euros, RCS Annecy, 303.970.230 - 09/2018.

**1** 2 x 

REPLACING A HOTEL SWITCH WITHOUT NEUTRAL BEHIND THE SWITCH  
 REMPLACER UN VA-ET-VIENT SANS NEUTRE DERRIÈRE L'INTERRUPTEUR  
 FLURSCHALTUNG OHNE NEUTRALLEITER HINTER DEM SCHALTER ERSETZEN

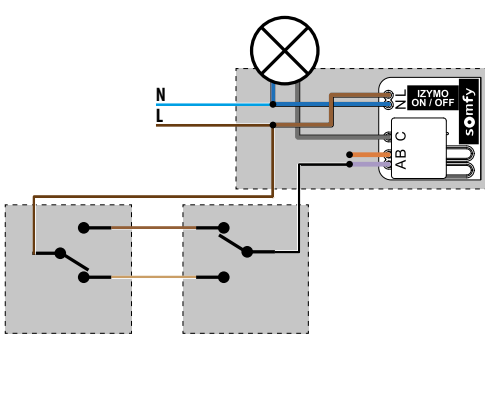
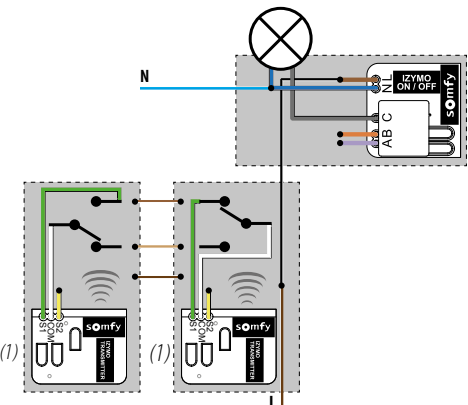
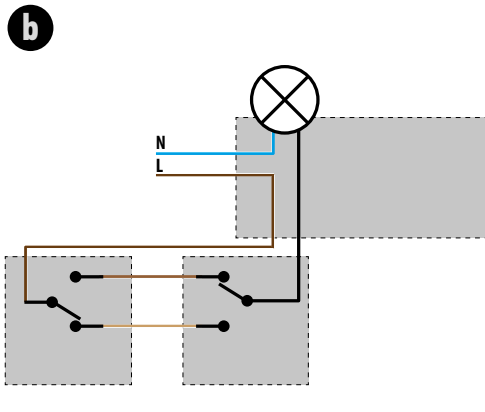
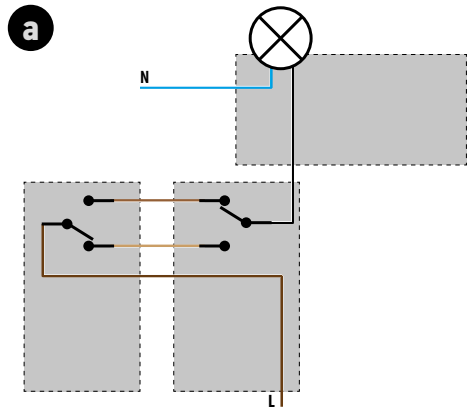

**2** 2 x 

REPLACING A HOTEL SWITCH WITH NEUTRAL BEHIND THE SWITCH  
 REMPLACER UN VA-ET-VIENT AVEC NEUTRE DERRIÈRE L'INTERRUPTEUR  
 FLURSCHALTUNG MIT NEUTRALLEITER HINTER DEM SCHALTER ERSETZEN

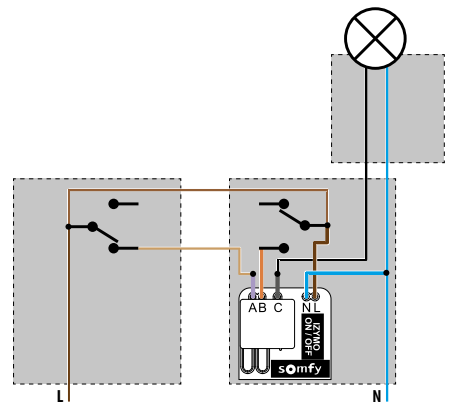
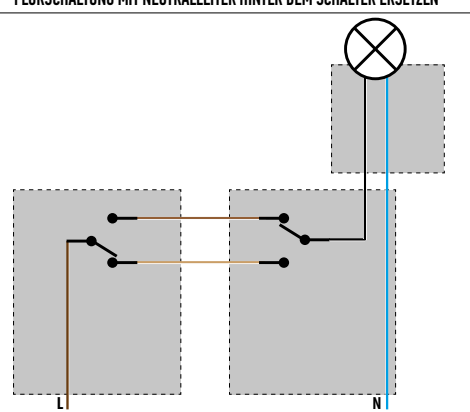

(1) IZymo TRANSMITTER IO SOLD SEPARATELY

**3** 1 x 

SIMPLE LIGHT  
 SIMPLE ALLUMAGE  
 EINZELNE BELEUCHTUNG

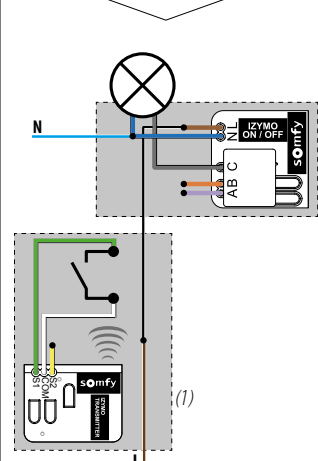
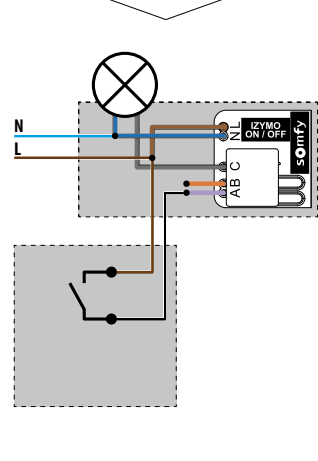
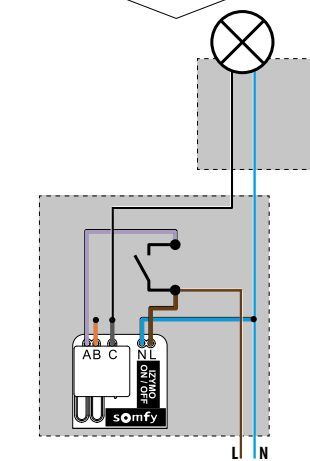
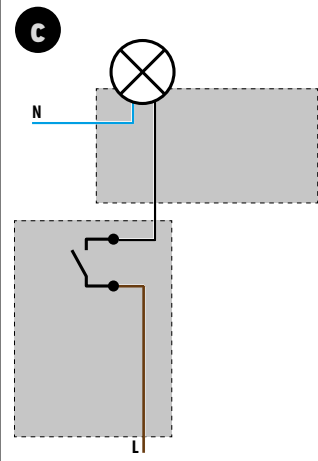
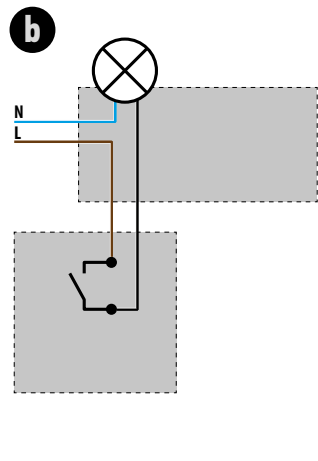
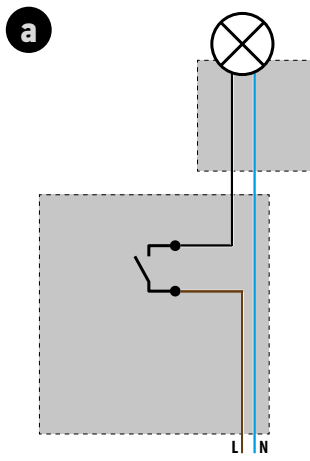

(1) IZymo TRANSMITTER IO SOLD SEPARATELY

**4** 1 x   
 n x 

LATCHING RELAY INSTALLATION  
 TÉLÉRUPTEUR  
 STROMSTOSSRELAIS

