

# RK3

## TASTIERA RADIO ROLLING CODE



## Manuale d'uso

CE

 **ALLMATIC**

## 1. Caratteristiche tecniche

Riferimento	RK3
Tasti	Policarbonato retroilluminato.
Canali	10
Codice Master programmazione	1
Codici utente	99
Impostazione tempo trasmissione	da 1 a 10 secondi
Compatibilità	Con tutti i prodotti Rolling Code Allmatic
Memoria	EEPROM (mantiene la programmazione intatta anche nel caso di mancanza di corrente)
Portata	120 mt in campo libero
Led verde	Pressione tasto / segnale errore e conferma / trasmissione in corso
Led rosso	Indicatore tastiera sbloccata
Led ambra	Ingresso nel menu di configurazione
Buzzer	1
Alimentazione	input 12/24V AC/DC e/o Batteria 9V
Consumo massimo	27mA in trasmissione con alimentazione batteria 9V 120mA in trasmissione con alimentazione 24Vac
Grado IP	65
Dimensioni (mm)	119,5x83,5x40

## 2. Montaggio

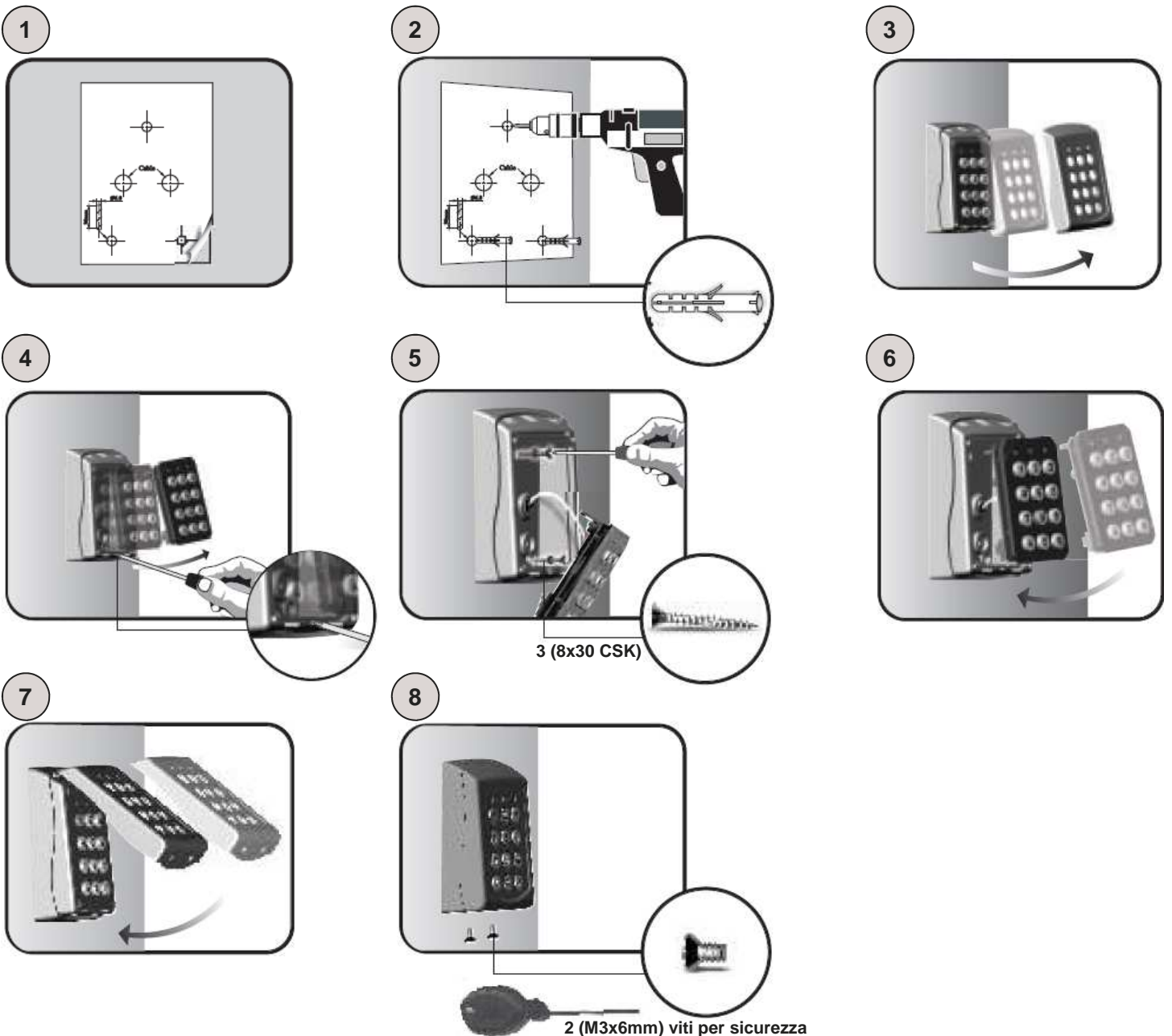

### 3. Codice Master

**ATTENZIONE:** Prima di effettuare qualsiasi operazione applicare nello spazio sottostante l'adesivo presente sul retro della tastiera (come indicato nel disegno) con riportato il codice master impostato di fabbrica.





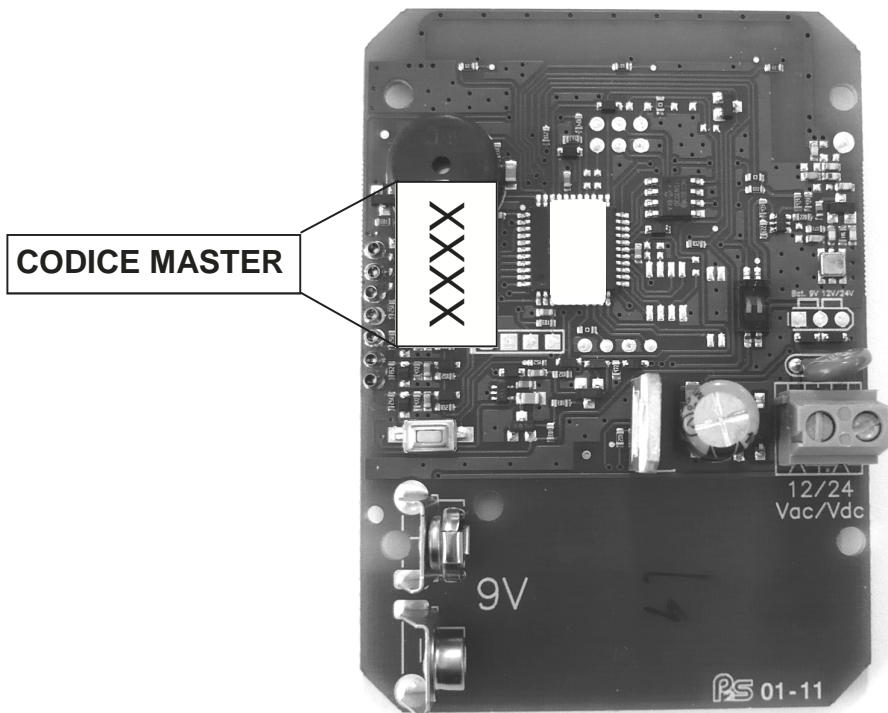

Incollare l'adesivo o scrivere qui il codice master



**ATTENZIONE:** In caso di reset totale del dispositivo, il codice master tornerà ad essere quello indicato. La perdita di questo codice renderà quindi inutilizzabile la tastiera.



### 4 Cambiare il codice Master

- 1 Inserire il **codice MASTER** (1-8 cifre). Vedi paragrafo 3
- 2 Convalidare premendo il tasto **B** 
  - Bip lungo + led AMBRA acceso **FISSO** - Convalida **OK**
  - Serie di bip brevi + lampeggio led AMBRA - Convalida **NON OK**
- 3 Premere **0**  La tastiera emette un **Bip lungo**
- 4 Digitare la locazione di memoria del master **00**  La tastiera emette un **Bip lungo**
- 5 Digitare il nuovo codice MASTER da 1 a 8 cifre  Se il codice è uguale a 8 cifre, la tastiera emette un **Bip lungo** per indicare la memorizzazione del codice.
- 6 Premere **A** (solo se il codice di accesso è inferiore ad 8 cifre)  La tastiera emette un **Bip lungo**
- 7 Premere B per uscire dal menu dal  La tastiera emette un **Bip lungo** + led ambra si **spegne**
- 8 Cambio codice terminato

**Il codice master viene utilizzato solo per la fase di programmazione.**

**Si consiglia in caso di cambio del codice master di riportarlo nell'apposito spazio sottostante.**

**NUOVO CODICE  
MASTER**

--	--	--	--	--	--	--	--

## 5 Memorizzare un codice Utente

- 1 Inserire il **codice MASTER** (1-8 cifre). Vedi paragrafo 3
- 2 Convalidare premendo il tasto **B** →
  - Bip lungo + led AMBRA accesso **FISSO** - Convalida **OK**
  - Serie di bip brevi + lampeggio led AMBRA - Convalida **NON OK**
- 3 Premere **0** → La tastiera emette un **Bip lungo**
- 4 Digitare la locazione di memoria dell'utente da memorizzare **01 a 99** → La tastiera emette un **Bip lungo**
- 5 Digitare il nuovo codice da 1 a 8 cifre per l'accesso dell'utente → Se il codice è uguale a 8 cifre, la tastiera emette un **Bip lungo** per indicare la memorizzazione del codice.
- 6 Premere **A** (solo se il codice di accesso è inferiore ad 8 cifre) → La tastiera emette un **Bip lungo**
- 7 Premere B per uscire dal menu dal → La tastiera emette un **Bip lungo** + led ambra si **spegne**
- 8 Memorizzazione terminata

La tastiera associa automaticamente il canale di trasmissione 1 ad ogni nuovo utente

Si consiglia di compilare il registro degli utenti per facilitare futuri interventi di modifica o di cancellazione.

### Esempio sequenza attivazione tastiera ( il codice utilizzato 9876 è casuale) e trasmissione con canale 1

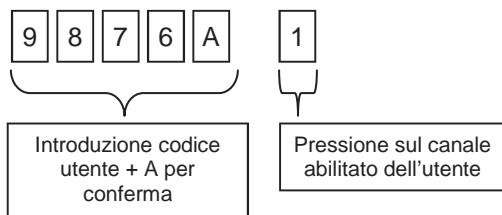



## 6 Assegnare i canali di trasmissione

- 1 Inserire il **codice MASTER** (1-8 cifre). Vedi paragrafo 3
- 2 Convalidare premendo il tasto **B** →
  - Bip lungo + led AMBRA accesso **FISSO** - Convalida **OK**
  - Serie di bip brevi + lampeggio led AMBRA - Convalida **NON OK**
- 3 Premere **3** → La tastiera emette un **Bip lungo**
- 4 Digitare la locazione di memoria dell'utente da abilitare **01 a 99** → La tastiera emette un **Bip lungo**
- 5 Premere i canali da abilitare da **1 a 10 (0)** → La tastiera emette un BIP ad ogni abilitazione
- 6 Premere **A** per memorizzare → La tastiera emette un **Bip lungo**
- 7 Premere B per uscire dal menu dal → La tastiera emette un **Bip lungo** + led ambra si **spegne**
- 8 Assegnazione terminata

La tastiera associa automaticamente il canale di trasmissione 1 ad ogni nuovo utente

Si consiglia di compilare il registro degli utenti per facilitare futuri interventi di modifica o di cancellazione.

## 7 Impostare la durata della trasmissione

- 1 Inserire il **codice MASTER** (1-8 cifre). Vedi paragrafo 3
- 2 Convalidare premendo il tasto **B** 
  - Bip lungo + led AMBRA accesso **FISSO** - Convalida **OK**
  - Serie di bip brevi + lampeggio led AMBRA - Convalida **NON OK**
- 3 Premere **1** 

La tastiera emette un **Bip lungo**
- 4 Inserire la durata della trasmissione da abilitare da **1s a 10s (0)** 



La tastiera emette un **Bip lungo** e memorizza il tempo inserito.
- 5 Premere **B** per uscire dal menu 

La tastiera emette un **Bip lungo** + led ambra si **spegne**
- 6 Impostazione terminata

Come impostazione predefinita, la durata della trasmissione è impostata a 2 secondi.

**Il tempo di trasmissione impostato è valido per TUTTI gli utenti e per TUTTI i canali di trasmissione**

## 8 Cancellare un utente

- 1 Inserire il **codice MASTER** (1-8 cifre). Vedi paragrafo 3
- 2 Convalidare premendo il tasto **B** 
  - Bip lungo + led AMBRA accesso **FISSO** - Convalida **OK**
  - Serie di bip brevi + lampeggio led AMBRA - Convalida **NON OK**
- 3 Premere **9** 

La tastiera emette un **Bip lungo**
- 4 Digitare la locazione di memoria dell'utente da cancellare **da 01 a 99** 



La tastiera emette un **Bip lungo**
- 6 Premere **A** per confermare 

La tastiera emette un **Bip lungo**
- 7 Premere **B** per uscire dal menu 

La tastiera emette un **Bip lungo** + led ambra si **spegne**
- 8 Cancellazione terminata

**Si consiglia di aggiornare il registro degli utenti**

## 9 Cancellare tutti gli utenti

- 1 Inserire il **codice MASTER** (1-8 cifre). Vedi paragrafo 3
- 2 Convalidare premendo il tasto **B** 
  - Bip lungo + led AMBRA accesso **FISSO** - Convalida **OK**
  - Serie di bip brevi + lampeggio led AMBRA - Convalida **NON OK**
- 3 Premere **8** 

La tastiera emette un **Bip lungo**
- 4 Digitare la locazione di memoria **99** 

La tastiera emette un **Bip lungo**
- 6 Premere **A** per confermare 

La tastiera emette un **Bip lungo**
- 7 Premere **B** per uscire dal menu 

La tastiera emette un **Bip lungo** + led ambra si **spegne**
- 8 Cancellazione totale terminata

**Si consiglia di aggiornare il registro degli utenti**

## 10. Riassunto programmazione

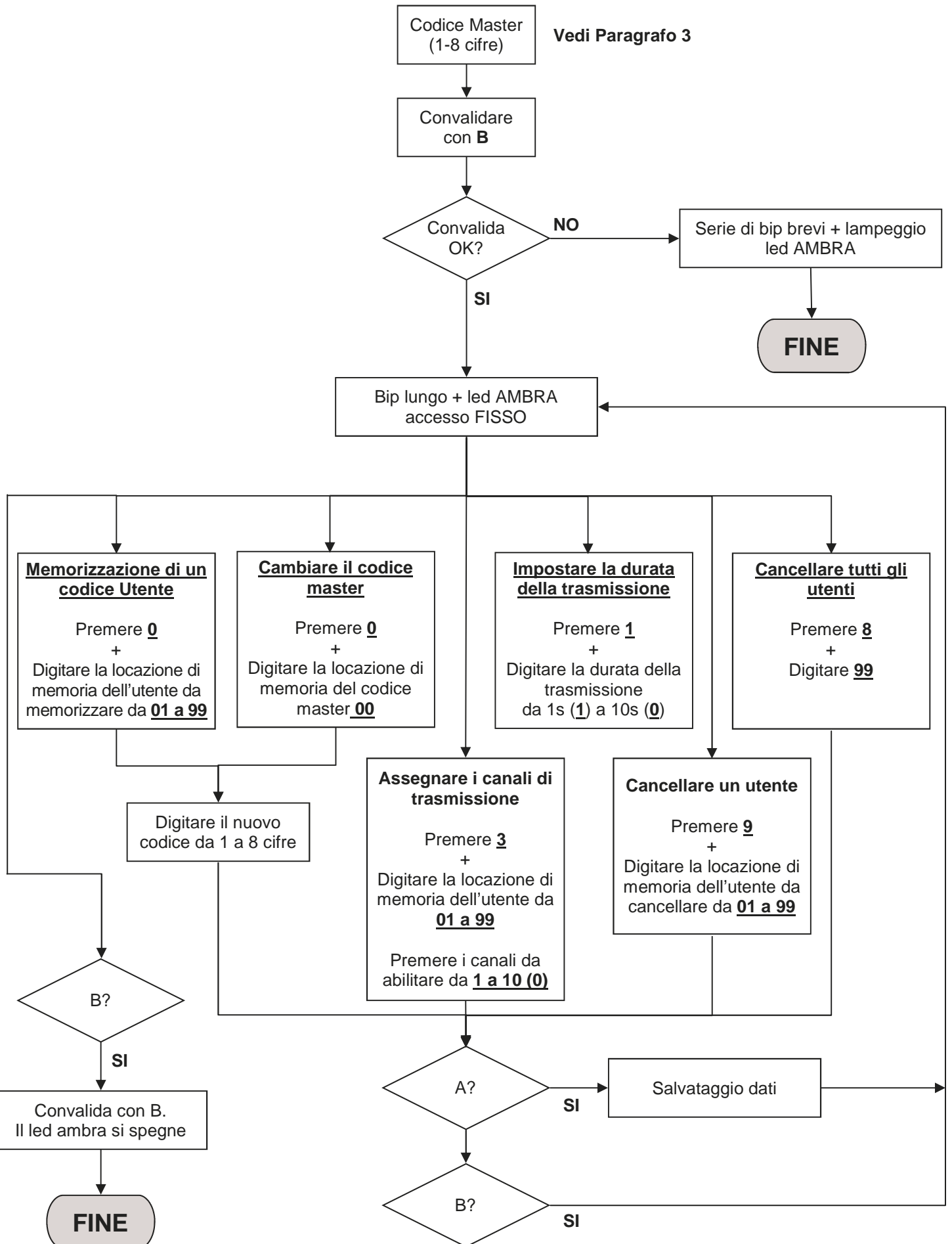

## 11. Impostazione DIP-SWITCH

Sulla parte posteriore della scheda è presente un DIP-SWITCH che permette di attivare / disattivare il buzzer e la retroilluminazione della tastiera.

**Per le operazioni di impostazione è consigliato di attivare il buzzer.**

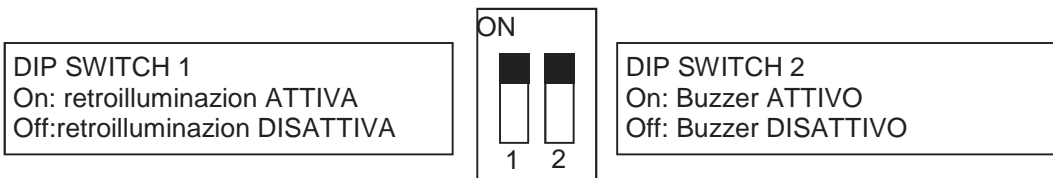

In caso di funzionamento a batteria, una volta terminata la programmazione si consiglia se possibile di mettere entrambi i dip-switch in posizione OFF per consentire un risparmio energetico maggiore ed aumentare così la durata di vita della batteria.

## 12. Reset totale dispositivo

- 1 Premere e mantenere premuto il tasto di reset.
- 2 La tastiera emette un BIP → NON rilasciare il tasto
- 3 La tastiera emette due BIP → NON rilasciare il tasto
- 4 La tastiera emette tre BIP → NON rilasciare il tasto
- 5 La tastiera emette un BIP continuo → Rilasciare il tasto
- 6 Reset totale terminato



**ATTENZIONE: IN CASO DI RESET TOTALE DEL DISPOSITIVO, TUTTI GLI UTENTI VENGONO CANCELLATI, IL CODICE MASTER (VEDI PARAGRAFO 3) E TUTTE LE IMPOSTAZIONI TORNANO AD ESSERE QUELLE IMPOSTATE DI FABBRICA.**



## 13 Esempio di programmazione

Questo esempio riporta la programmazione del dispositivo con il codice utente "123456" abilitato a trasmettere sul canale "4" con una durata di trasmissione di 6 secondi. Il codice master impostato di fabbrica per questo esempio è "9876".  
**Si consiglia sempre di modificare il codice master impostandone uno proprio.**

### 1. Cambio del codice Master

Qui sotto viene riportato la sequenza da introdurre per cambiare il codice master (nel nostro esempio "9876") con il codice "456789" (questo codice deve essere scelto dal cliente, vedi paragrafo 3 e 4)

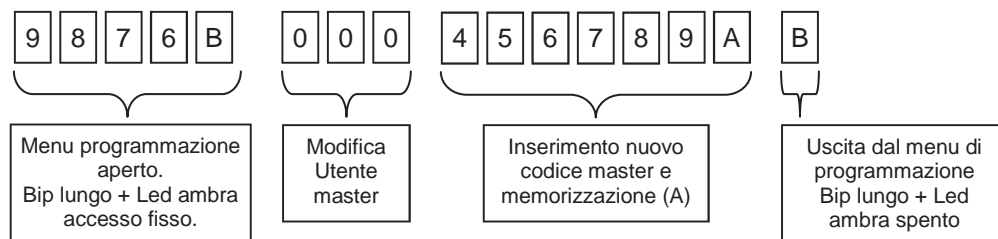

### 2. Impostazione codice utente

Qui sotto viene riportato la sequenza da introdurre per creare un utente sull'allocazione di memoria "01" con il codice di accesso "123456". Vedi paragrafo 5.

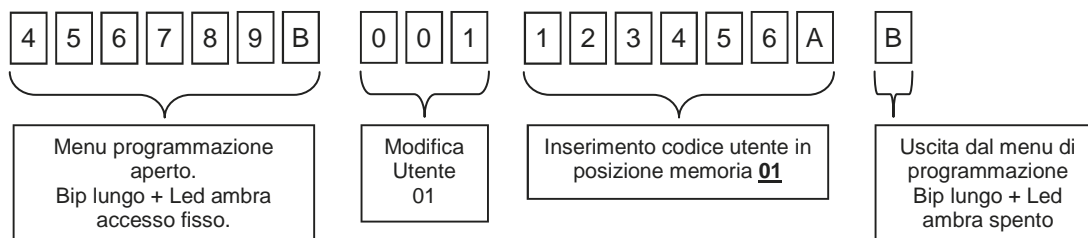

### 3. Impostazione canale trasmissione

Come impostazione predefinita, ad ogni nuovo utente il dispositivo assegna automaticamente il canale 1.

Qui sotto viene riportato la sequenza da introdurre per abilitare il canale di trasmissione "4" all'utente posizionato alla allocazione di memoria 01. Vedi paragrafo 6.

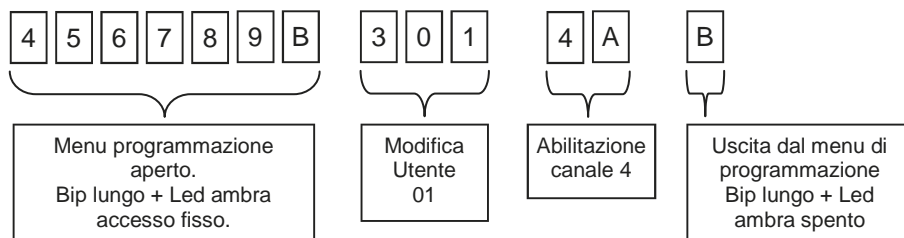

### 4. Impostazione durata trasmissione

Come impostazione predefinita, la durata della trasmissione è impostata a 2 secondi.

Qui sotto viene riportato la sequenza da introdurre per impostare la durata di trasmissione a 6 secondi per TUTTI i canali e TUTTI gli utenti. Vedi paragrafo 7.

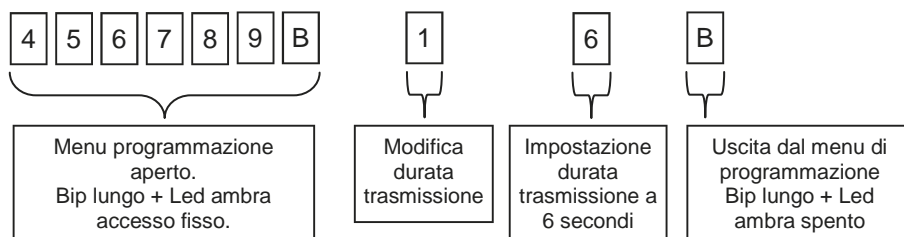

### 5. Memorizzazione della tastiera sull'automazione

Entrare in modalità apprendimento sulla centralina/ricevitore in uso, inserire il codice utente (es.123456) sulla tastiera RK3, premere il tasto A e successivamente premere il tasto del canale (es.4) che si desidera memorizzare.

1 2 3 4 5 6 A 4



**Registro utenti**

Posizione memoria	Codice utente	Nome	Cognome	Canali attivi																
				1	2	3	4	5	6	7	8	9	0							
01																				
02																				
03																				
04																				
05																				
06																				
07																				
08																				
09																				
10																				
11																				
12																				
13																				
14																				
15																				
16																				
17																				
18																				
19																				
20																				
21																				
22																				
23																				
24																				
25																				
26																				
27																				
28																				
29																				
30																				
31																				
32																				
33																				

Posizione memoria	Codice utente	Nome	Cognome	Canali attivi											
				1	2	3	4	5	6	7	8	9	0		
34															
35															
36															
37															
38															
39															
40															
41															
42															
43															
44															
45															
46															
47															
48															
49															
50															
51															
52															
53															
54															
55															
56															
57															
58															
59															
60															
61															
62															
63															
64															
65															
66															

Posizione memoria	Codice utente	Nome	Cognome	Canali attivi											
				1	2	3	4	5	6	7	8	9	0		
67															
68															
69															
70															
71															
72															
73															
74															
75															
76															
77															
78															
79															
80															
81															
82															
83															
84															
85															
86															
87															
88															
89															
90															
91															
92															
93															
94															
95															
96															
97															
98															
99															

GARANZIA - La garanzia del produttore ha validità a termini di legge dalla data stampigliata sul prodotto ed è limitata alla riparazione o sostituzione gratuita dei pezzi riconosciuti dallo stesso come difettosi per mancanza di qualità essenziali nei materiali o per deficienza di lavorazione. La garanzia non copre danni o difetti dovuti ad agenti esterni, deficienza di manutenzione, sovraccarico, usura naturale, scelta del tipo inesatto, errore di montaggio, o altre cause non imputabili al produttore. I prodotti manomessi non saranno né garantiti né riparati. I dati riportati sono puramente indicativi. Nessuna responsabilità potrà essere addebitata per riduzioni di portata o disfunzioni dovute ad interferenze ambientali. La responsabilità a carico del produttore per i danni derivati a chiunque da incidenti di qualsiasi natura cagionati da nostri prodotti difettosi, sono soltanto quelle che derivano inderogabilmente dalla legge italiana.



ALLMATIC S.r.l  
32020 Lentiai - Belluno - Italy  
Via dell'Artigiano, n°1 - Z.A.  
Tel. 0437 751175 - 751163 r.a. Fax 0437 751065  
<http://www.allmatic.com> - E-mail: [info@allmatic.com](mailto:info@allmatic.com)

# RK3

## ROLLING CODE RADIO KEYBOARD



## Manual



## 1. Technical features

Reference	RK3
Keys	Backlit polycarbonate
Channels	10
Programming Master Code	1
Users codes	99
Relays time setup	1 to 10 seconds
Compatibility	With all Allmatic's Rolling Code products
Memory	EEPROM (keeps programming safe even in case of power cut)
Range	120 mt in open space
Green led	Key pressure / error and confirmation signal / transmission in progress
Red led	Keypad unlocked indicator
Amber led	Configuration menu entrance
Buzzer	1
Power supply	12/24V AC/DC input and/or 9V battery
Max absorption	27mA in transmission with 9V battery power supply 120mA in transmission with 24Vac power supply
IP rating	65
Dimensions (mm)	119,5x83,5x40

## 2. Mounting

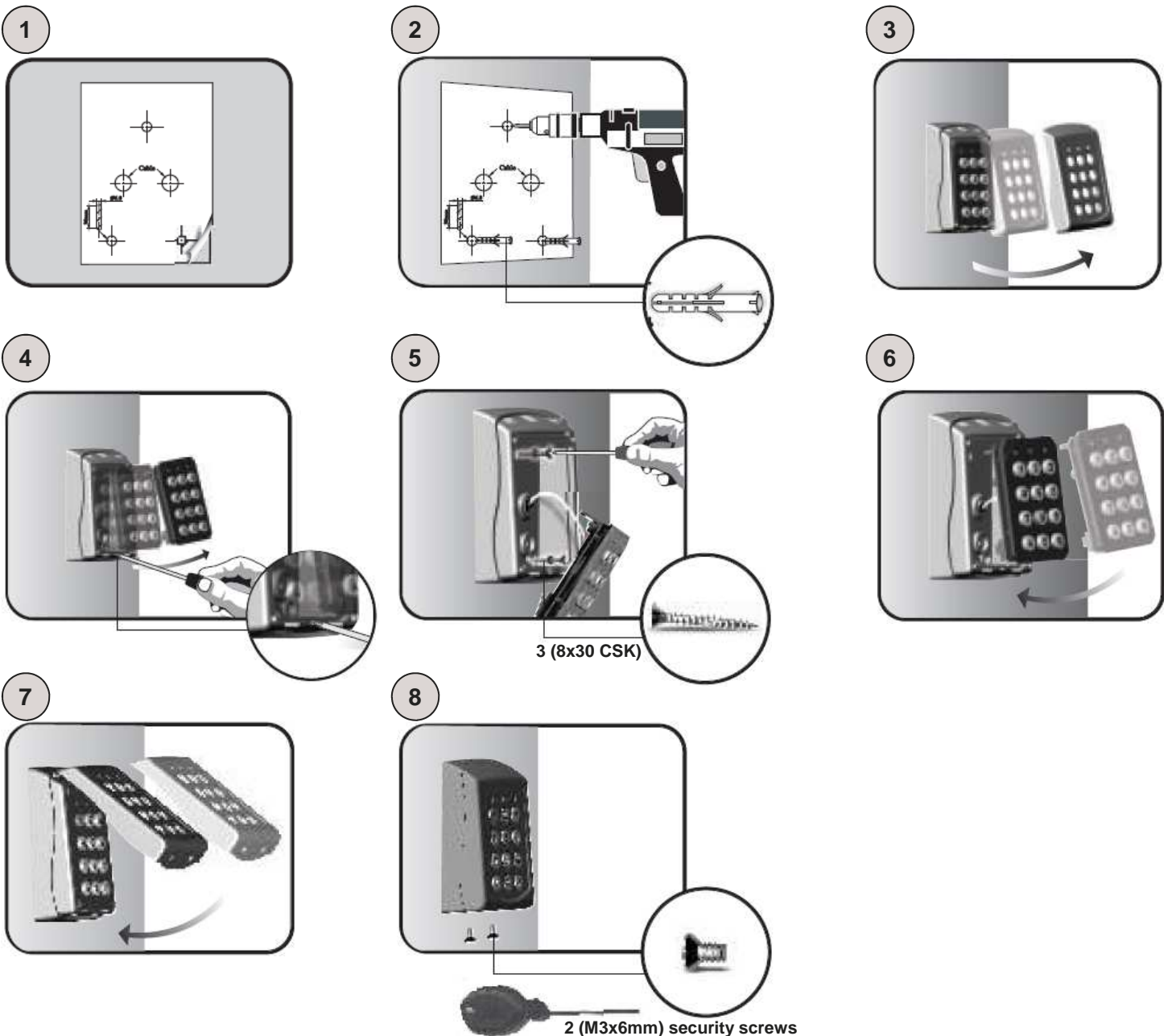

### 3. Master Code

**ATTENTION:** Before making any operation, take the adhesive you find on the back of the keyboard and put it on the space here below (as shown in the drawing) where it is written the master code set by the factory.

Attach here the adhesive or write the master code



**ATTENTION:** In case of total reset of the device, the master code will come to be the one indicated. The loss of this code will make the keyboard unusable.

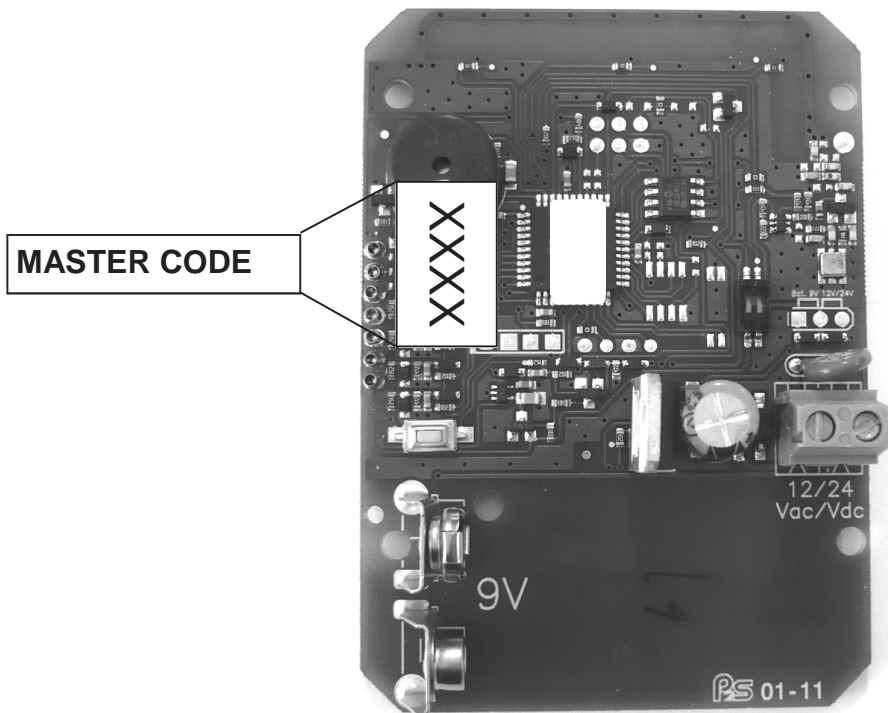

### 4 Changing the master code

- 1 Enter the **MASTER code** (1-8 figures). See Paragraph 3
- 2 Confirm by pressing the **B** ⇒
  - Long Beep + Amber led **FIX ON** - Confirm **OK**
  - Series of short Beeps + Amber led flashing - Confirm **NOT OK**
- 3 Press **0** ⇒ **Long Beep** emitted by the keyboard
- 4 Enter the memory location of the master **00** ⇒ **Long Beep** emitted by the keyboard
- 5 Enter the new MASTER code from 1 to 8 figures long ⇒ If the code is 8 figures long, the keyboard emits a **Long Beep** to indicate that the code is memorized
- 6 Press **A** (only if the access code is shorter that 8 figures) ⇒ **Long Beep** emitted by the keyboard
- 7 Press **B** to exit ⇒ **Long Beep emitted** by the keyboard + amber led **OFF**
- 8 Code changing terminated

The master code is used only for programming.

In case of changing of the master code, it is suggested to write it down here below.

NEW MASTER  
CODE

--	--	--	--	--	--	--	--



## 5 Memorizing a new user code

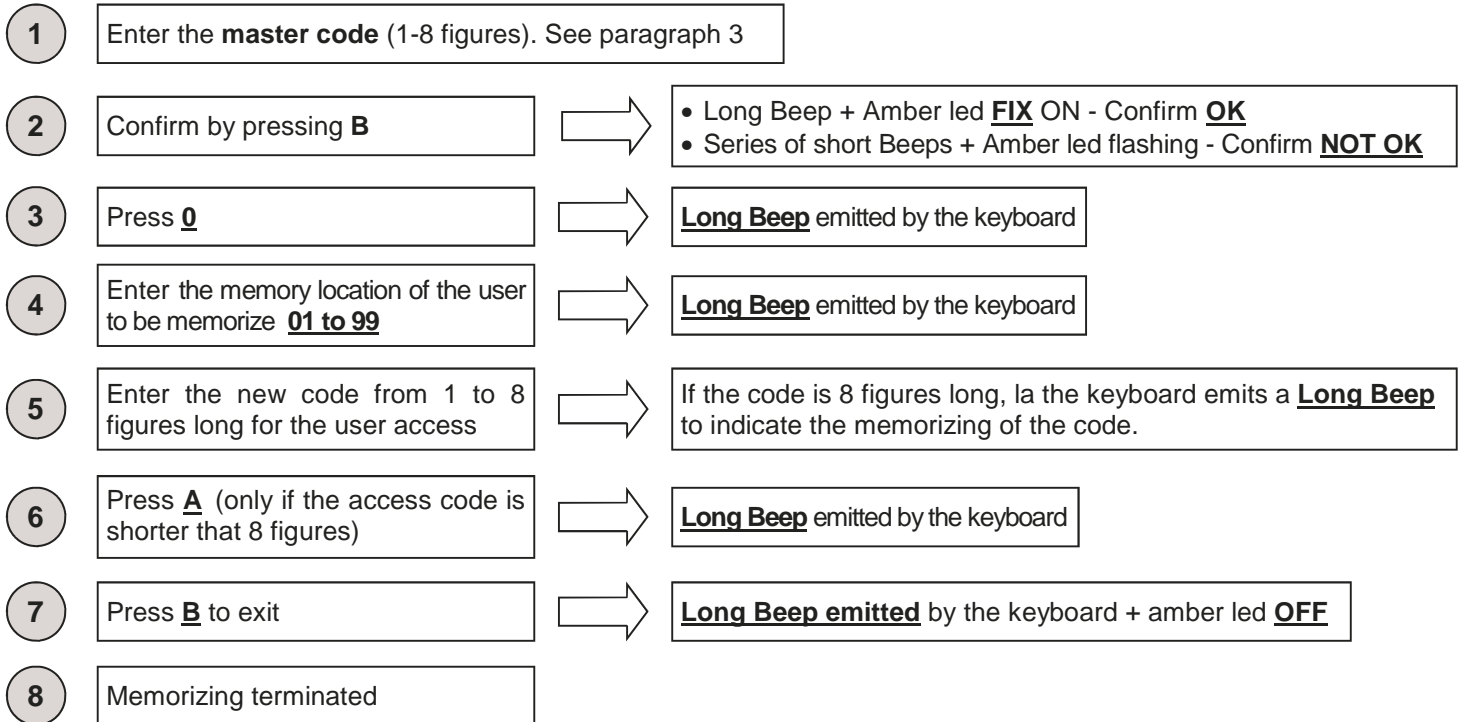

The keyboard automatically associates the transmission channel 1 to every new user  
It is suggested to fill the users book in order to facilitate the future maintenance for changing or cancellation.

### Example of keyboard activation sequence (if code 9876 is random) and transmission with channel 1

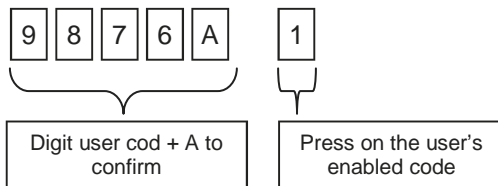

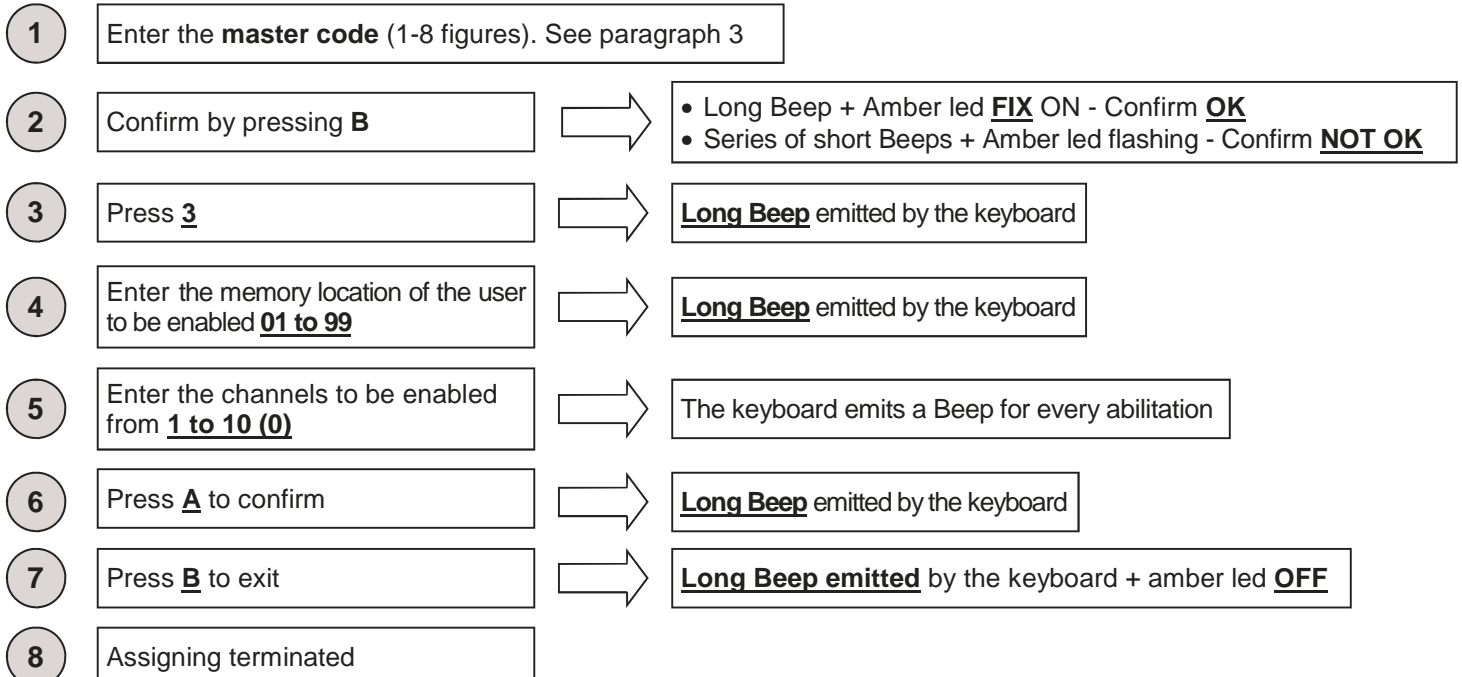

## 6 Assigning the transmission channels



The keyboard automatically associates the transmission channel 1 to every new user  
It is suggested to fill the users book in order to facilitate the future maintenance for changing or cancellation.

## 7 Transmission duration setup

- 1 Enter the **master code** (1-8 figures). See paragraph 3
- 2 Confirm by pressing **B** 
  - Long Beep + Amber led **FIX ON** - Confirm **OK**
  - Series of short Beeps + Amber led flashing - Confirm **NOT OK**
- 3 Press **1** 

**Long Beep** emitted by the keyboard
- 4 Enter the transmission time to be enabled from **1s to 10s (0)** 



**Long Beep** emitted by the keyboard and memorize the time entered
- 5 Press **B** to exit 

**Long Beep emitted** by the keyboard + amber led **OFF**
- 6 Setup terminated

The transmission time is set to 2 seconds by default.

**The transmission time setting applies to ALL users and ALL transmission channels**

## 8 Deleting one user

- 1 Digit the **master code** (1-8 figures). See paragraph 3
- 2 Confirm by pressing **B** 
  - Long Beep + Amber led **FIX ON** - Confirm **OK**
  - Series of short Beeps + Amber led flashing - Confirm **NOT OK**
- 3 Press **9** 

**Long Beep** emitted by the keyboard
- 4 Enter the memory location of the user to be deleted **from 01 to 99** 



**Long Beep** emitted by the keyboard
- 6 Press **A** to confirm 

**Long Beep** emitted by the keyboard
- 7 Press **B** to exit 

**Long Beep emitted** by the keyboard + amber led **OFF**
- 8 Deleting terminated

**It is suggested to update the user register**

## 9 Deleting all users

- 1 Digit the **master code** (1-8 figures). See paragraph 3
- 2 Confirm by pressing **B** 
  - Long Beep + Amber led **FIX ON** - Confirm **OK**
  - Series of short Beeps + Amber led flashing - Confirm **NOT OK**
- 3 Press **8** 

**Long Beep** emitted by the keyboard
- 4 Enter the memory location **99** 

**Long Beep** emitted by the keyboard
- 6 Press **A** to confirm 

**Long Beep** emitted by the keyboard
- 7 Press **B** to exit 

**Long Beep emitted** by the keyboard + amber led **OFF**
- 8 Total deleting terminated

**It is suggested to update the users book**

## 10. Programming summary

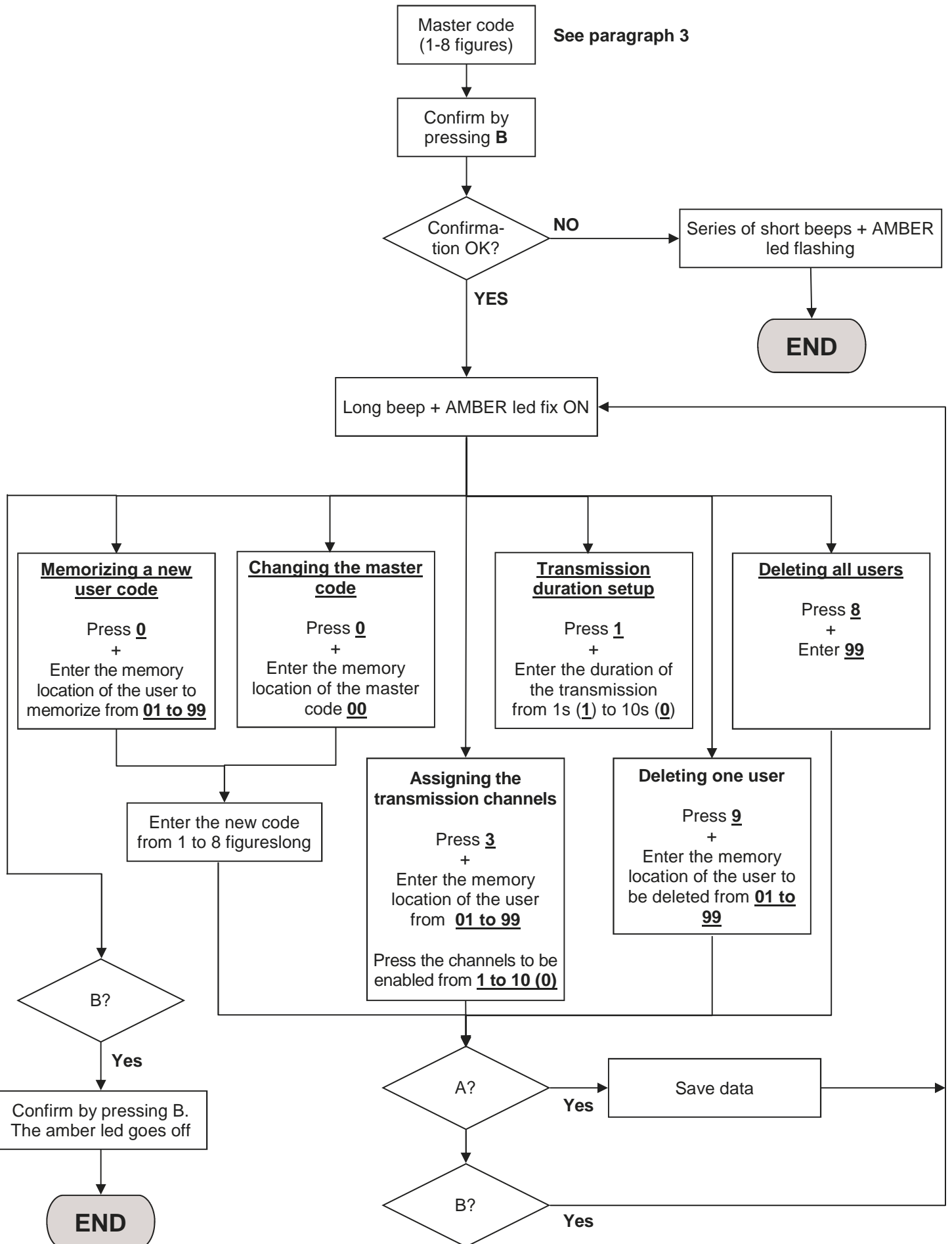

## 11. DIP-SWITCH setup

On the back side of the card there is a DIP-SWITCH that allows to enable / disable the buzzer and the backlighting of the keyboard.

**It is suggested to enable the buzzer during the setup operation.**

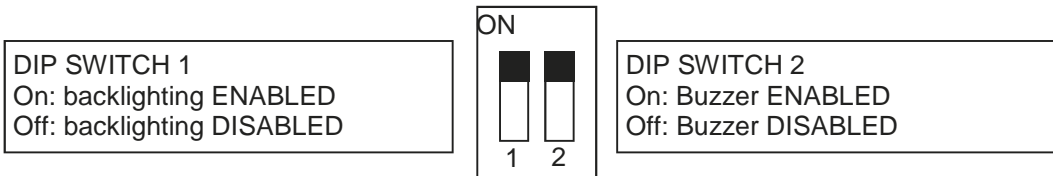

In case of battery supply, once the programming is terminated it is suggested to turn both the dip-switch OFF in order to improve the efficiency and increase the lifetime of the battery.

## 12 Device Total Reset

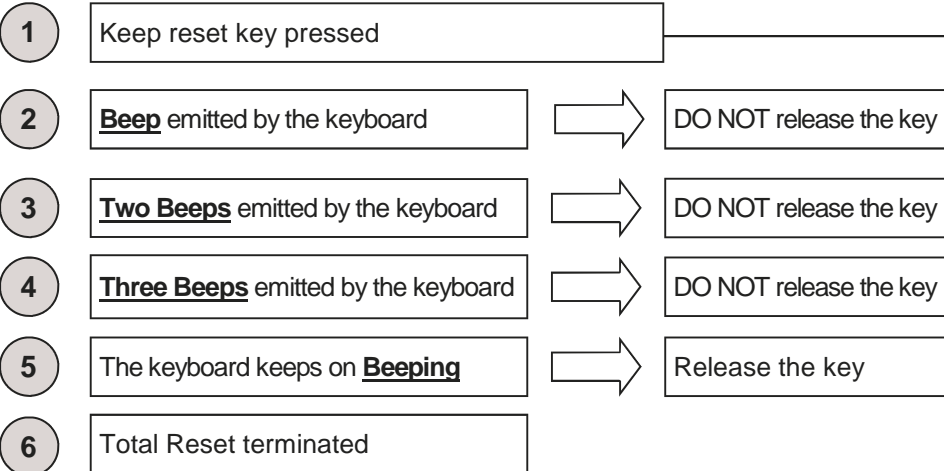

**ATTENTION: IN CASE OF TOTAL RESET ALL THE USERS ARE DELETED, THE MASTER CODE (SEE PARAGRAPH 3) AND ALL THE SETTINGS RETURN TO BE THOSE SET BY THE FACTORY.**

## 13 Programming example

This is an example for programming the device with user code "123456" enabled to transmit on channel "4" with a transmission duration of 6 seconds. The master code set by the factory in this example is "9876".

**It is suggested to modify the master code in order to set a new one.**

### 1. Change of the master code

Here below it is shown the sequence to enter to change the master code (in this example it is "9876") with the code "456789" (this code must be chosen by the client, see paragraph 3 and 4)

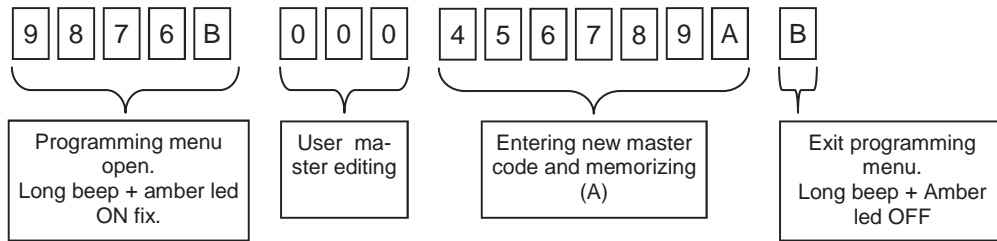

### 2. User Code Setup

Here below it is shown the sequence to enter to create a new user on the memory location "01" with the access code "123456". See paragraph 5.

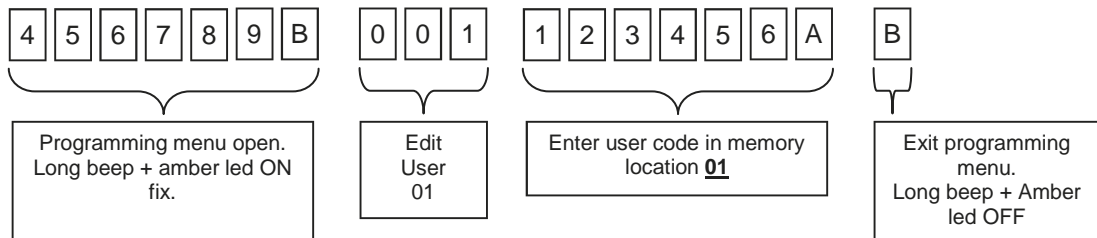

### 3. Transmission channel setup

As default settings, the device assigns channel 1 to every new user.

Here below it is shown the sequence to enter to enable the transmission channel "4" to the user on memory location 01. See paragraph 6.

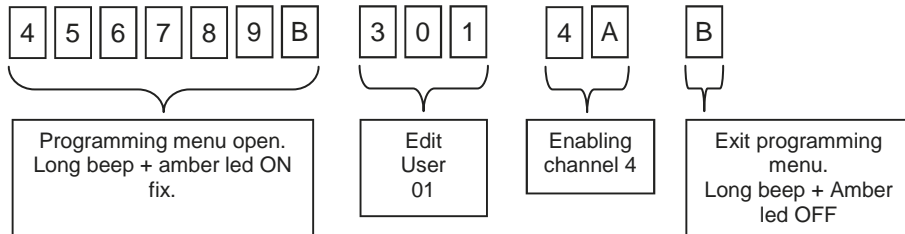

### 4. Transmission Duration Setup

As default settings, the transmission duration is set to 2 seconds.

Here below it is shown the sequence to enter to set the transmission duration to 6 seconds for ALL channels and ALL users. See paragraph 7.

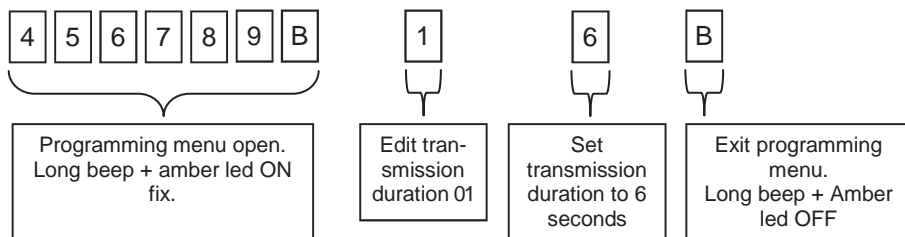

### 5. Learning the keypad on the installation

Enable the learning mode on the control unit/receiver used, press on the RK3 the user code (ex.123456), press A and after press the key of the channel (ex.4) you want to memorize.

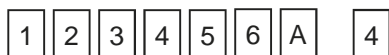

**Users book**

Memory position	User code	Name	Surname	Active channels																	
				1	2	3	4	5	6	7	8	9	0								
01																					
02																					
03																					
04																					
05																					
06																					
07																					
08																					
09																					
10																					
11																					
12																					
13																					
14																					
15																					
16																					
17																					
18																					
19																					
20																					
21																					
22																					
23																					
24																					
25																					
26																					
27																					
28																					
29																					
30																					
31																					
32																					
33																					

Memory position	User code	Name	Surname	Active channels											
				1	2	3	4	5	6	7	8	9	0		
34															
35															
36															
37															
38															
39															
40															
41															
42															
43															
44															
45															
46															
47															
48															
49															
50															
51															
52															
53															
54															
55															
56															
57															
58															
59															
60															
61															
62															
63															
64															
65															
66															



Memory position	User code	Name	Surname	Active channels											
				1	2	3	4	5	6	7	8	9	0		
67															
68															
69															
70															
71															
72															
73															
74															
75															
76															
77															
78															
79															
80															
81															
82															
83															
84															
85															
86															
87															
88															
89															
90															
91															
92															
93															
94															
95															
96															
97															
98															
99															

WARRANTY - The manufacturer's warranty is valid according to the terms of the law from the date printed on the product and is limited to the free reparation or replacement of defective parts acknowledged to be defective because of deficiencies in essential material properties or manufacturing faults. The warranty does not cover damage or failure due to external agents, insufficient maintenance, overload, wear and tear, choice of the incorrect type, incorrect installation, or other causes not related to the producer. The products will not be tampered with or repaired nor guaranteed. The data shown are for guidance only. No liability can be accepted for reductions in range or failure due to environmental interference. The responsibility borne by the producer for damage caused to anyone by accident of any kind by faulty products, is only that required by the Italian law.



ALLMATIC S.r.l  
32020 Lentiai - Belluno - Italy  
Via dell'Artigiano, n°1 - Z.A.  
Tel. 0437 751175 - 751163 r.a. Fax 0437 751065  
<http://www.allmatic.com> - E-mail: [info@allmatic.com](mailto:info@allmatic.com)

# RK3

CLAVIER RADIO ROLLING CODE



**NOTICE**

**CE**

**AM ALLMATIC**

## 1. Caractéristiques techniques

Référence	RK3
Touche	Polycarbonate rétro illuminé
Canaux	10
Code Master de programmation	1
Codes utilisateurs	99
Réglage temps transmission	de 1 à 10 secondes
Compatibilité	Avec tous les produits Rolling Code Allmatic
Mémoire	EEPROM (maintient la programmation intacte même en cas de coupure de courant)
Portée	120 mt en champs libre
Led verte	Pression touche / signale erreur et confirmation / transmission en cours
Led rouge	Indicateur clavier débloqué
Led ambrée	Entrée dans le menu de configuration
Buzzer	1
Alimentation	input 12/24V AC/DC et/ou Batterie 9V
Consommation maximale	27mA en transmission avec alimentation batterie 9V 120mA en transmission avec alimentation 24Vac
Degré IP	65
Dimensions (mm)	119,5x83,5x40

## 2. Montage

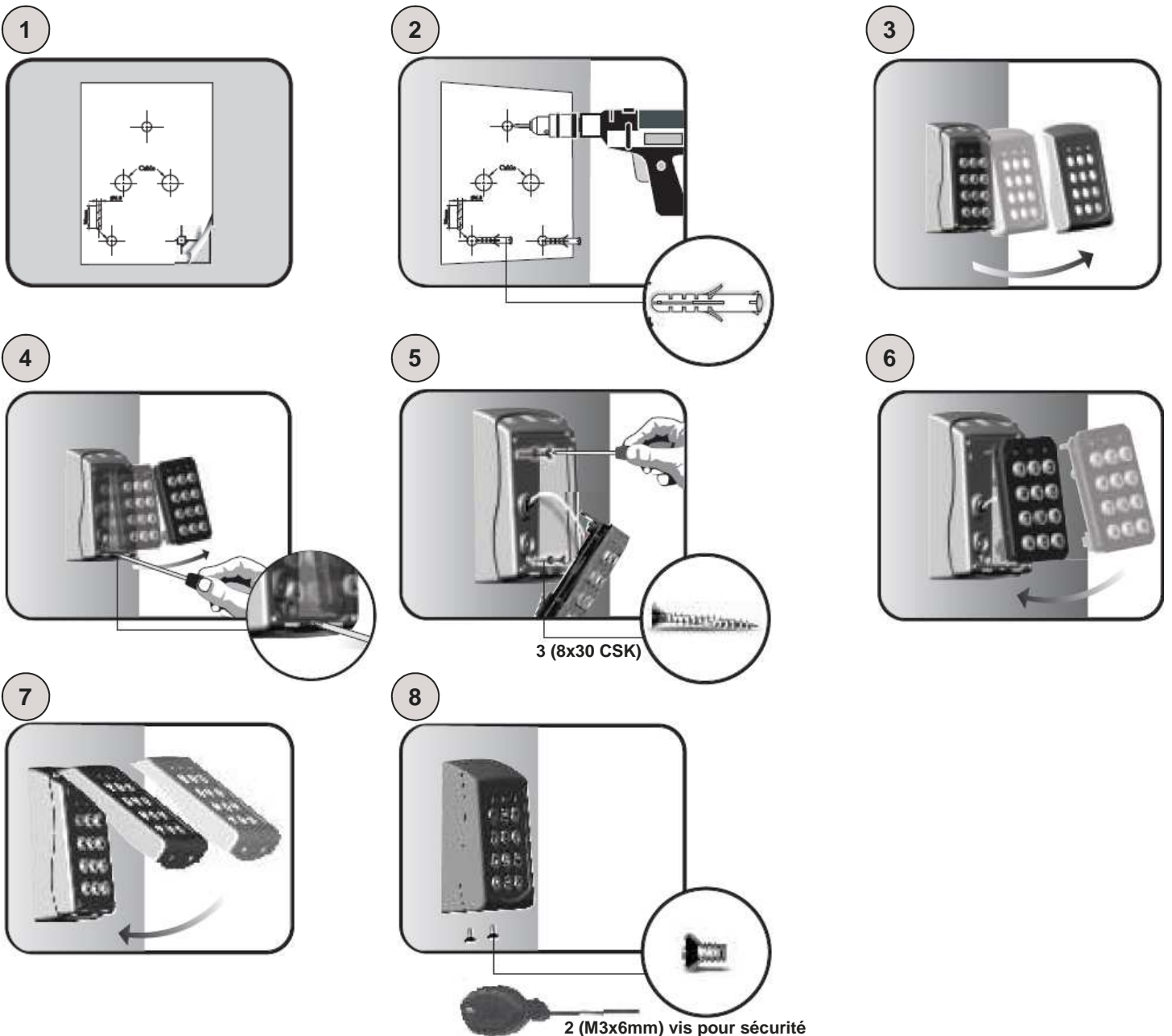

### 3. Code Master

**ATTENTION:** Avant d'effectuer toutes opérations, appliquer dans l'espace ci-dessous l'autocollant présent sur le dos du clavier (comme indiqué dans le dessin) avec reporté le code master mémorisé d'usine.

Coller l'autocollant ou écrire ici  
le code master

**ATTENTION:** En cas de reset total du dispositif, le code master retourne à être celui indiqué. La perte de ce code rendra le dispositif inutilisable.

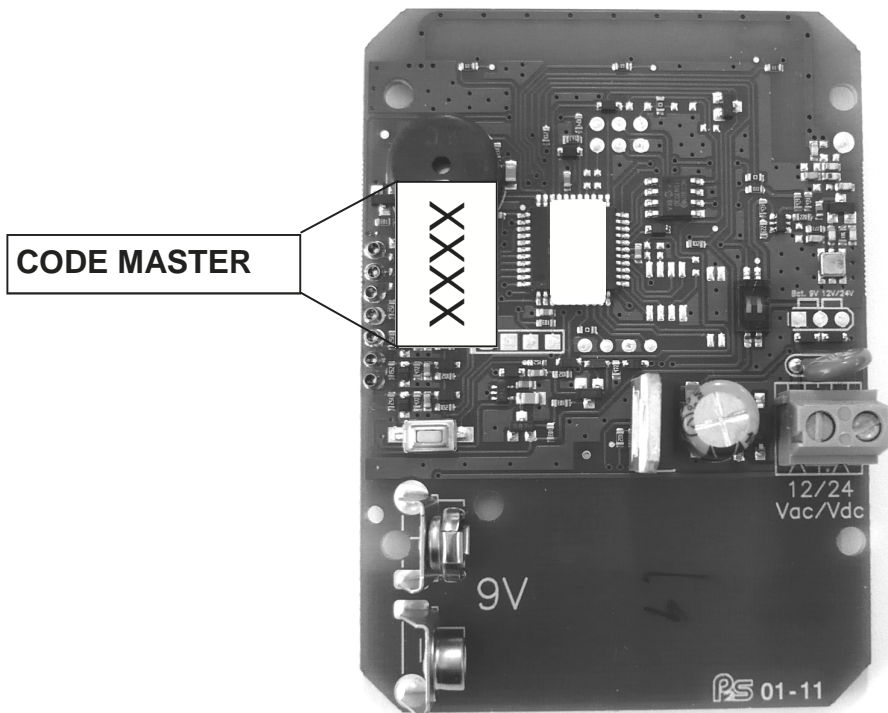

### 4 Changer le code master

- 1 Introduire le **code MASTER** (1-8 chiffres). Cf. paragraphe 3
- 2 Valider avec la touche **B** ⇒
  - Bip long + led AMBRÉE Allumée **FIXE** - Validation **OK**
  - Série de bip brefs + clignotement led AMBRÉE - Validation **NON OK**
- 3 Appuyer sur **0** ⇒ Le clavier émet un **Bip long**
- 4 Introduire la position de mémoire du code master **00** ⇒ Le clavier émet un **Bip long**
- 5 Introduire le nouveau code MASTER de 1 à 8 chiffres ⇒ Si le code est égal à 8 chiffres, le clavier émet un **Bip long** pour indiquer la mémorisation du code.
- 6 Appuyer sur **A** (seulement si le code d'accès est inférieur à 8 chiffres) ⇒ Le clavier émet un **Bip long**
- 7 Appuyer sur **B** pour sortir du menu ⇒ Le clavier émet un **Bip long** + led ambrée s'éteint
- 8 Changement du code terminé

**Le code master est utilisé seulement pour la phase de programmation.**  
**Il est conseillé en cas de changement du code master de le reporter dans l'espace ci-dessous.**

**NOUVEAU CODE  
MASTER**

--	--	--	--	--	--	--	--

## 5 Mémoriser un code Utilisateur

- 1 Introduire le **code MASTER** (1-8 chiffres). Cf. paragraphe 3
- 2 Valider avec la touche **B** →
  - Bip long + led AMBRÉE Allumée **FIXE** - Validation **OK**
  - Série de bip brefs + clignotement led AMBRÉE - Validation **NON OK**
- 3 Appuyer sur **0** → Le clavier émet un **Bip long**
- 4 Introduire la position de mémoire de l'utilisateur à mémoriser **01 à 99** → Le clavier émet un **Bip long**
- 5 Introduire le nouveau code de 1 à 8 chiffres pour l'accès de l'utilisateur → Si le code est égal à 8 chiffres, le clavier émet un **Bip long** pour indiquer la mémorisation du code.
- 6 Appuyer sur **A** (seulement si le code d'accès est inférieur à 8 chiffres) → Le clavier émet un **Bip long**
- 7 Appuyer sur **B** pour sortir du menu → Le clavier émet un **Bip long** + led ambrée s'éteint
- 8 Changement du code terminé

Le clavier associe automatiquement le canal de transmission 1 à tous les nouveaux utilisateurs.  
Il est conseillé de compiler le registre des utilisateurs pour faciliter les modifications ou effacements futures

### Exemple de séquence d'activation du clavier (le code utilisateur 9876 est casuel) et transmission avec le canal 1

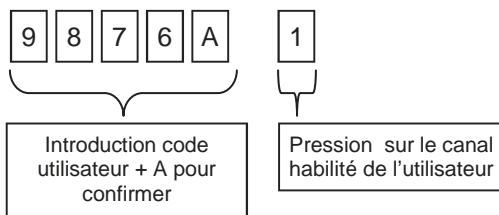

## 6 Attribuer les canaux de transmission

- 1 Introduire le **code MASTER** (1-8 chiffres). Cf. paragraphe 3
- 2 Valider avec la touche **B** →
  - Bip long + led AMBRÉE Allumée **FIXE** - Validation **OK**
  - Série de bip brefs + clignotement led AMBRÉE - Validation **NON OK**
- 3 Appuyer sur **3** → Le clavier émet un **Bip long**
- 4 Introduire la position de mémoire de l'utilisateur **01 à 99** → Le clavier émet un **Bip long**
- 5 Appuyer sur les canaux à attribuer de **1 à 10 (0)** → Le clavier émet un Bip à chaque attribution
- 6 Appuyer sur **A** pour mémoriser → Le clavier émet un **Bip long**
- 7 Appuyer sur **B** pour sortir du menu → Le clavier émet un **Bip long** + led ambrée s'éteint
- 8 Changement du code terminé

Le clavier associe automatiquement le canal de transmission 1 à tous les nouveaux utilisateurs.  
Il est conseillé de compiler le registre des utilisateurs pour faciliter les modifications ou effacements futures

## 7 Régler le temps de la transmission

- 1 Introduire le **code MASTER** (1-8 chiffres). Cf. paragraphe 3
- 2 Valider avec la touche **B** →
  - Bip long + led AMBRÉE Allumée **FIXE** - Validation **OK**
  - Série de bip brefs + clignotement led AMBRÉE - Validation **NON OK**
- 3 Appuyer sur **1** → Le clavier émet un **Bip long**
- 4 Introduire la durée de la transmission e1 **1s a 10s (0)** → Le clavier émet un **Bip long** et mémorise le temps introduit.
- 5 Appuyer sur **B** pour sortir du menu → Le clavier émet un **Bip long** + led ambrée s'éteint
- 6 Réglage terminé

Comme réglage d'usine, la durée de la transmission est réglée à 2 secondes.

**Le temps de transmission réglé est valable pour TOUS les utilisateurs et pour TOUS les canaux de transmission**

## 8 Effacer un utilisateur

- 1 Introduire le **code MASTER** (1-8 chiffres). Cf. paragraphe 3
- 2 Valider avec la touche **B** →
  - Bip long + led AMBRÉE Allumée **FIXE** - Validation **OK**
  - Série de bip brefs + clignotement led AMBRÉE - Validation **NON OK**
- 3 Appuyer sur **9** → Le clavier émet un **Bip long**
- 4 Introduire la position de mémoire de l'utilisateur à effacer de **01 à 99** → Le clavier émet un **Bip long**
- 6 Appuyer sur **A** pour confirmer → Le clavier émet un **Bip long**
- 7 Appuyer sur **B** pour sortir du menu → Le clavier émet un **Bip long** + led ambrée s'éteint
- 8 Effacement terminé

**Il est conseillé d'ajourné le registre des utilisateurs**

## 9 Effacer tous les utilisateurs

- 1 Introduire le **code MASTER** (1-8 chiffres). Cf. paragraphe 3
- 2 Valider avec la touche **B** →
  - Bip long + led AMBRÉE Allumée **FIXE** - Validation **OK**
  - Série de bip brefs + clignotement led AMBRÉE - Validation **NON OK**
- 3 Appuyer sur **8** → Le clavier émet un **Bip long**
- 4 Introduire la position de mémoire **99** → Le clavier émet un **Bip long**
- 6 Appuyer sur **A** pour confirmer → Le clavier émet un **Bip long**
- 7 Appuyer sur **B** pour sortir du menu → Le clavier émet un **Bip long** + led ambrée s'éteint
- 8 Effacement total terminé

**Il est conseillé d'ajourné le registre des utilisateurs**



## 10. Résumé programmation

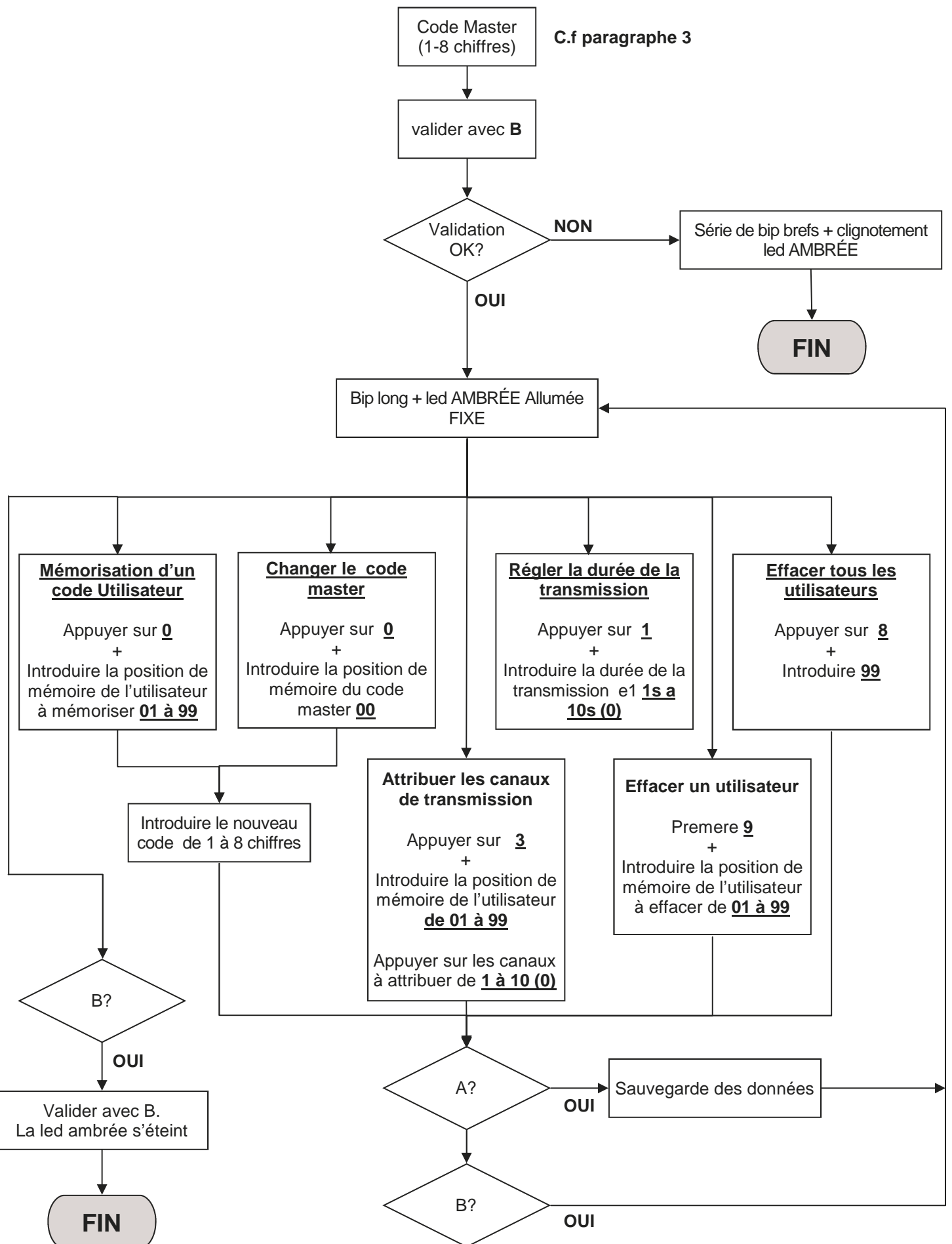

## 11. Réglage DIP-SWITCH

Sur la partie postérieure du clavier est présent un DIP-SWITCH qui permet d'activer / désactiver le buzzer et la rétro illumination du clavier.

**Pour les opérations de réglage il est conseillé d'activer le buzzer.**

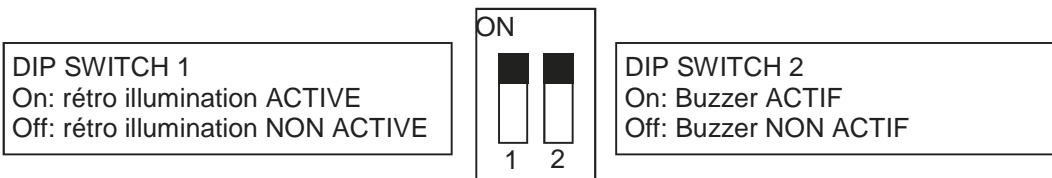

En cas de fonctionnement à batterie, une fois terminée la programmation, il est conseillé si possible de mettre les deux dip-switch en position OFF pour permettre une épargne d'énergie majeure et augmenter ainsi la durée de vie de la batterie.

## 12 Reset total du dispositif

- 1 Appuyer et maintenir appuyer la touche reset
- 2 Le clavier émet un BIP → NE PAS relâché la touche
- 3 Le clavier émet deux BIPS → NE PAS relâché la touche
- 4 Le clavier émet trois BIPS → NE PAS relâché la touche
- 5 Le clavier émet un BIP continu → Relâché la touche
- 6 Reset total terminé



**ATTENTION: EN CAS DE RESET TOTAL DU DISPOSITIF, TOUS LES UTILISATEURS SERONT EFFACE, LE CODE MASTER (C.F. PARAGRAPHE 3) ET TOUS LES REGLAGES RETOURNE A CEUX REGLE D'USINE.**

### 13 Exemple de programmation

Cet exemple reporte la programmation du dispositif avec un code utilisateur "123456" habilité à transmettre sur le canal "4" avec une durée de transmission de 6 secondes. Le code master réglé d'usine pour cette exemple est "9876".

**Il est conseillé de toujours changer le code master avec un propre code.**

#### 1. Changement du code master

Ci-dessous est reportée la séquence à introduire pour changer le code master (dans notre exemple "9876") avec le code "456789" (ce code doit être choisi par le client, cf. 3 et 4)

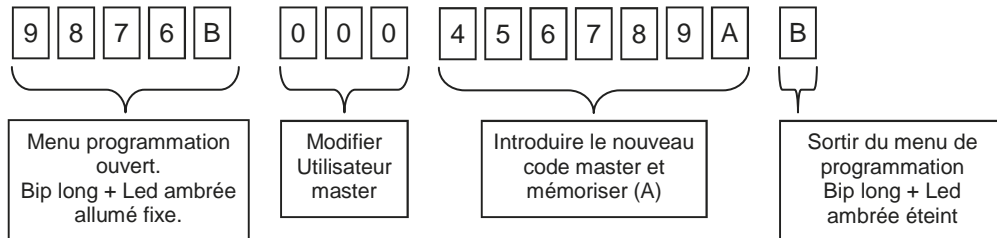

#### 2. Réglage code utilisateur

Ci-dessous est reportée la séquence à introduire pour créer un utilisateur sur la position de mémoire "01" avec le code d'accès "123456". Cf. paragraphe 5.

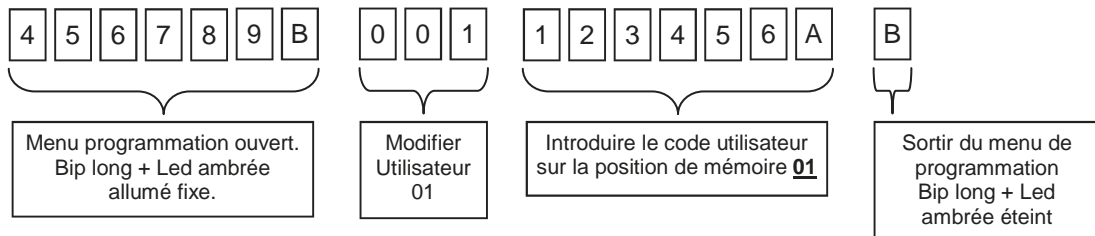

#### 3. Réglage des canaux de transmission

Comme réglage prédéfini, à tous les nouveaux utilisateurs le canal 1 est habilité automatiquement.

Ci-dessous est reportée la séquence à introduire pour habilité le canal de transmission "4" à l'utilisateur qui est sur la position de mémoire 01. Cf. paragraphe 6.

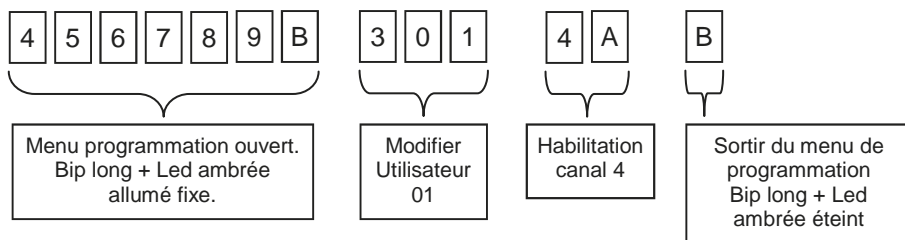

#### 4. Réglage durée de transmission

Comme réglage prédéfini, la durée de la transmission est réglée à 2 secondes.

Ci-dessous est reportée la séquence à introduire pour régler la durée de la transmission à 6 secondes pour TOUS les canaux et TOUS les utilisateurs. Cf. paragraphe 7.

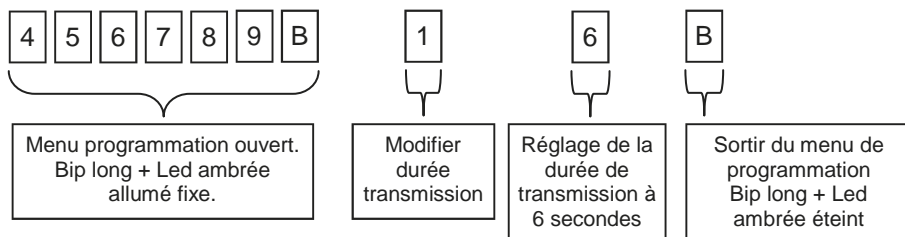

#### 5. Mémorisation du RK3 sur l'installation

Entrer dans la modalité apprentissage transmetteurs sur la centrale/récepteur en usage, taper le code utilisateur (es.123456) sur le clavier RK3, appuyer A et après la touche du canal (es.4) que l'on veut mémoriser .

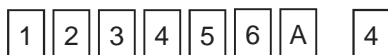

**Registre utilisateurs**

Position mémoire	Code utilisateur	Nom	Prénom	Canaux actifs																	
				1	2	3	4	5	6	7	8	9	0								
01																					
02																					
03																					
04																					
05																					
06																					
07																					
08																					
09																					
10																					
11																					
12																					
13																					
14																					
15																					
16																					
17																					
18																					
19																					
20																					
21																					
22																					
23																					
24																					
25																					
26																					
27																					
28																					
29																					
30																					
31																					
32																					
33																					

Position mémoire	Code utilisateur	Nom	Prénom	Canaux actifs											
				1	2	3	4	5	6	7	8	9	0		
34															
35															
36															
37															
38															
39															
40															
41															
42															
43															
44															
45															
46															
47															
48															
49															
50															
51															
52															
53															
54															
55															
56															
57															
58															
59															
60															
61															
62															
63															
64															
65															
66															

Position mémoire	Code utilisateur	Nom	Prénom	Canaux actifs											
				1	2	3	4	5	6	7	8	9	0		
67															
68															
69															
70															
71															
72															
73															
74															
75															
76															
77															
78															
79															
80															
81															
82															
83															
84															
85															
86															
87															
88															
89															
90															
91															
92															
93															
94															
95															
96															
97															
98															
99															

GARANTIE - La garantie du producteur a une validité conforme aux dispositions de la loi à compter de la date estampillée sur le produit et se limite à la réparation ou substitution gratuite des pièces reconnues par le fabricant comme défectueuses pour cause de défaut des caractéristiques essentielles des matériaux ou pour cause de défaut d'usinage. La garantie ne couvre pas les dommages ou défauts dus aux agents externes, à tout manque d'entretien, toute surtension, usure naturelle, tout choix inadapté du type de produit, toute erreur de montage, ou autres causes non imputables au producteur. Les produits modifiés ne seront ni garantis ni réparés. Les données reportées sont purement indicatives. Le producteur ne pourra en aucun cas être reconnu comme responsable des réductions de portée ou diffusions dues à toute interférence environnementale. La responsabilité du producteur pour les dommages subis par toute personne pour cause d'accidents de toute nature dus à un produit défectueux, est limitée aux responsabilités visées par la loi italienne.



ALLMATIC S.r.l.  
32020 Lentiai - Belluno - Italy  
Via dell'Artigiano, n°1 - Z.A.  
Tel. 0437 751175 - 751163 r.a. Fax 0437 751065  
<http://www.allmatic.com> - E-mail: [info@allmatic.com](mailto:info@allmatic.com)

# RK3

TECLADO RADIO ROLLING CODE



Manual

CE

 ALLMATIC



## 1. Características técnicas

Referencia	RK3
Teclas	Policarbonato retroiluminado
Canales	10
Master Code (programación)	1
Códigos usuarios	99
Regulación tiempo transmisión	de 1 a 10 segundos
Compatibilidad	Con todos los productos Rolling Code Allmatic
Memoria	EEPROM (mantiene la programación intacta incluso en el caso de apagón)
Alcance	120 metros en campo libre
Led verde	Presión tecla / señal de error y confirmación / transmisión en curso
Led rojo	Indicador teclado bloqueado
Led amarillo	Ingreso en el menú de configuración
Buzzer	1
Alimentación	input 12/24V AC/DC y/o batería 9V
Consumo	27mA in transmisión con alimentación batería 9V 120mA n transmisión con alimentación 24Vac
Indice de protección IP	65
Dimensiones (mm)	119,5x83,5x40

## 2. Montaje

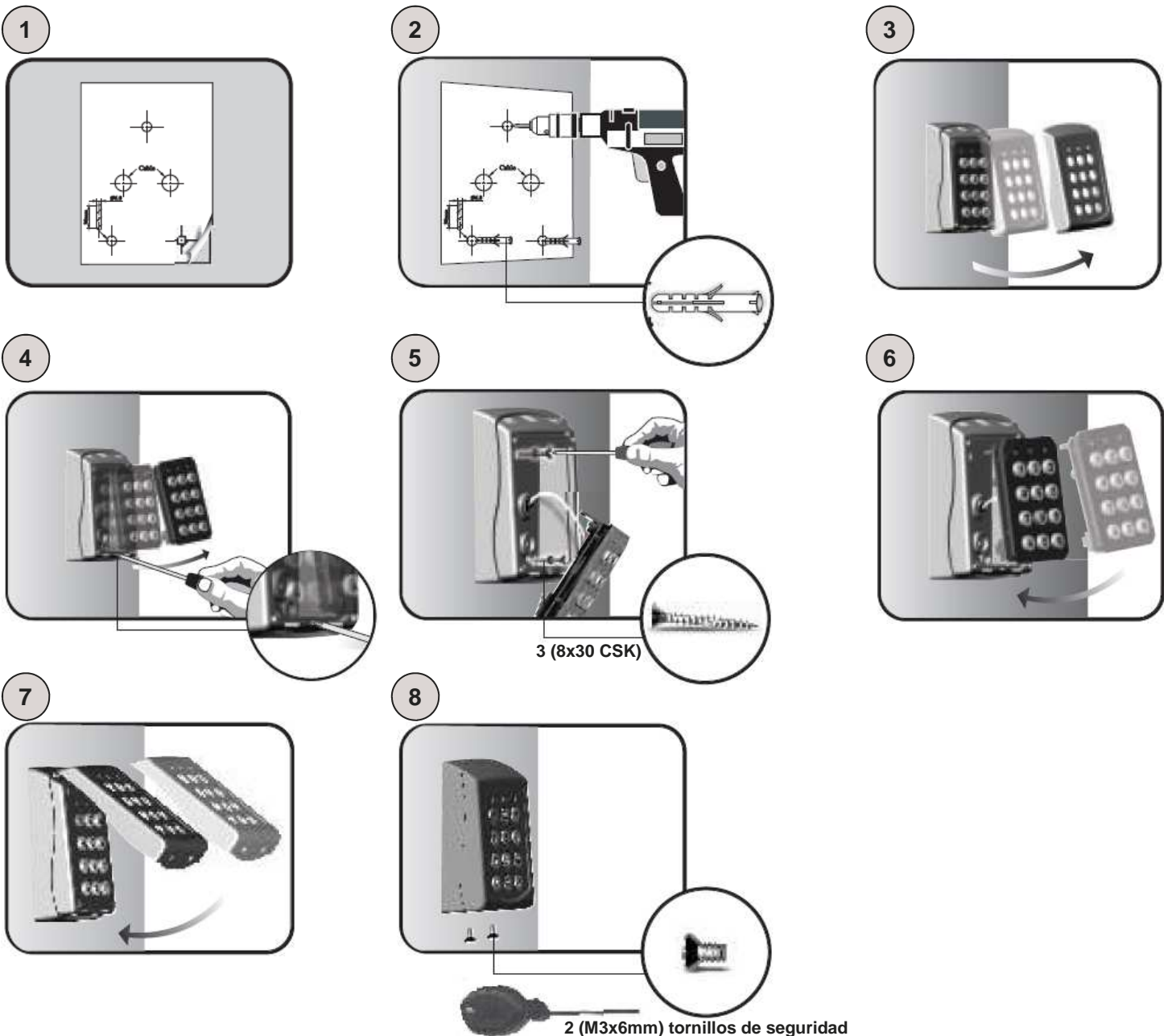

### 3. Código maestro

**ATENCIÓN:** Antes de realizar cualquier operación, el adhesivo que se encuentra en la parte posterior del teclado ponerlo en el espacio aquí abajo (como se muestra en el dibujo) donde está escrito el código maestro fijado por la fábrica.



Coloque aquí el adhesivo o escriba el código maestro



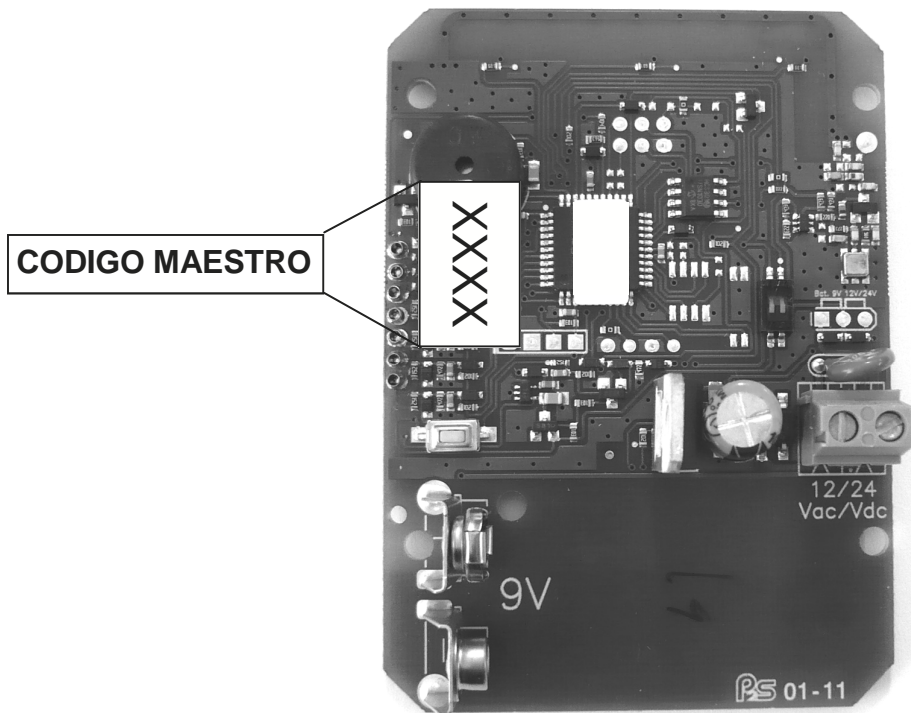

**ATENCIÓN:** En caso de reiniciación total del dispositivo, el código maestro volverá a ser el indicado. La pérdida de este código hará el teclado inutilizable.





### 4 Cambiar el código maestro

- 1 Introducir el **código maestro** (1-8 cifras). Véase el apartado 3
- 2 Confirmar presionando la tecla **B** 
  - Bip largo + led amarillo **FIJO** encendido - Confirmación **OK**
  - Serie de Bip cortos + destello led amarillo - Confirmación **NO OK**
- 3 Presionar **0** 

El teclado emite un **Bip largo**
- 4 Introducir la locación de memoria del maestro **00** 

El teclado emite un **Bip corto**
- 5 Introducir el nuevo código maestro de 1 a 8 cifras 

Si el código tiene 8 figuras, el teclado emite un **Bip largo** para indicar que el código está memorizado
- 6 Presionar **A** (sólo si el código es menor de 8 cifras) 

El teclado emite un **Bip largo**
- 7 Presionar **B** para salir 

El teclado emite un **Bip largo** + led amarillo **apagado OFF**
- 8 Cambio de código terminado

**El código maestro se usa sólo para la programación.**

**En el caso de cambio de código maestro, se le sugiere escribirlo aquí abajo.**

**NUEVO CODIGO MAESTRO**

--	--	--	--	--	--	--	--

## 5 Memorizar un nuevo código usuario

- 1 Introducir el **código maestro** (1-8 cifras). Véase el apartado 3
- 2 Confirmar presionando la tecla **B** →
  - Bip largo + led amarillo **FIJO** encendido - Confirmación **OK**
  - Serie de Bip cortos + destello led amarillo - Confirmación **NO OK**
- 3 Presionar **0** → El teclado emite un **Bip largo**
- 4 Introducir la locación de memoria del usuario de **01 a 99** → El teclado emite un **Bip largo**
- 5 Introducir el nuevo código de 1 a 8 cifras para el acceso del usuario → Si el código tiene 8 cifras, el teclado emite un **Bip largo** para indicar la memorización del código
- 6 Presionar **A** (sólo si el código de acceso es menor de 8 cifras) → El teclado emite un **Bip largo**
- 7 Presionar **B** para salir → El teclado emite un **Bip largo** + led amarillo **apagado OFF**
- 8 Memorización terminada

El teclado asocia automáticamente el canal de transmisión 1 a todos los nuevos usuarios.

Se sugiere rellenar el registro de usuarios para facilitar el mantenimiento futuro de cambio o cancelación.

### Ejemplo de secuencia de activación del teclado (código al azar 9876) y transmisión con el canal 1

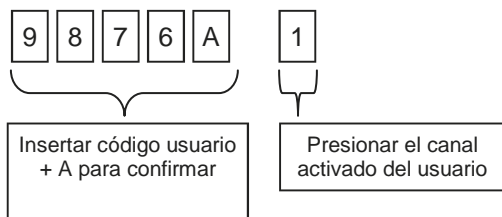

## 6 Asignar los canales de transmisión

- 1 Introducir el **código maestro** (1-8 cifras). Véase el apartado 3
- 2 Confirmar presionando la tecla **B** →
  - Bip largo + led amarillo **FIJO** encendido - Confirmación **OK**
  - Serie de Bip cortos + destello led amarillo - Confirmación **NO OK**
- 3 Presionar **3** → El teclado emite un **Bip largo**
- 4 Introducir la locación de memoria del usuario de **01 a 99** → El teclado emite un **Bip largo**
- 5 Presionar los canales de **1 a 10 (0)** → El teclado emite un Bip para cada habilitación
- 6 Confirmar presionando la tecla **A** → El teclado emite un **Bip largo**
- 7 Presionar **B** para salir → El teclado emite un **Bip largo** + led amarillo **apagado OFF**
- 8 Asignación terminada

El teclado asocia automáticamente el canal de transmisión 1 a todos los nuevos usuarios.

Se sugiere rellenar el registro de usuarios para facilitar el mantenimiento futuro de cambios o cancelación.

## 7 Fijar la duración de la transmisión

- 1 Introducir el **código maestro** (1-8 cifras). Véase el apartado 3
- 2 Confirmar presionando la tecla **B** →
  - Bip largo + led amarillo **FIJO** encendido - Confirmación **OK**
  - Serie de Bip cortos + destello led amarillo - Confirmación **NO OK**
- 3 Presionar **1** → El teclado emite un **Bip largo**
- 4 Introducir la duración de la transmisión de **1s a 10s (0)** → El teclado emite un **Bip largo** y memoriza el tiempo insertado
- 5 Presionar **B** para salir → El teclado emite un **Bip largo** + led amarillo **apagado OFF**
- 6 Configuración terminada

La duración de la transmisión está configurada en 2 segundos por defecto.

La configuración de la duración se aplica a **TODOS** los usuarios y **TODOS** los canales de transmisión

## 8 Suprimir un usuario

- 1 Introducir el **código maestro** (1-8 cifras). Véase el apartado 3
- 2 Confirmar presionando la tecla **B** →
  - Bip largo + led amarillo **FIJO** encendido - Confirmación **OK**
  - Serie de Bip cortos + destello led amarillo - Confirmación **NO OK**
- 3 Presionar **9** → El teclado emite un **Bip largo**
- 4 Introducir la locación de memoria del usuario de **01 a 99** → El teclado emite un **Bip largo**
- 6 Confirmar presionando la tecla **A** → El teclado emite un **Bip largo**
- 7 Presionar **B** para salir → El teclado emite un **Bip largo** + led amarillo **apagado OFF**
- 8 Supresión terminada

Se sugiere rellenar el registro de usuarios

## 9 Suprimir todos los usuarios

- 1 Introducir el **código maestro** (1-8 cifras). Véase el apartado 3
- 2 Confirmar presionando la tecla **B** →
  - Bip largo + led amarillo **FIJO** encendido - Confirmación **OK**
  - Serie de Bip cortos + destello led amarillo - Confirmación **NO OK**
- 3 Presionar **8** → El teclado emite un **Bip largo**
- 4 Introducir la locación de memoria **99** → El teclado emite un **Bip largo**
- 6 Confirmar presionando la tecla **A** → El teclado emite un **Bip largo**
- 7 Presionar **B** para salir → El teclado emite un **Bip largo** + led amarillo **apagado OFF**
- 8 Supresión total terminada

Se sugiere rellenar el registro de usuarios

## 10. Resumen de Programación

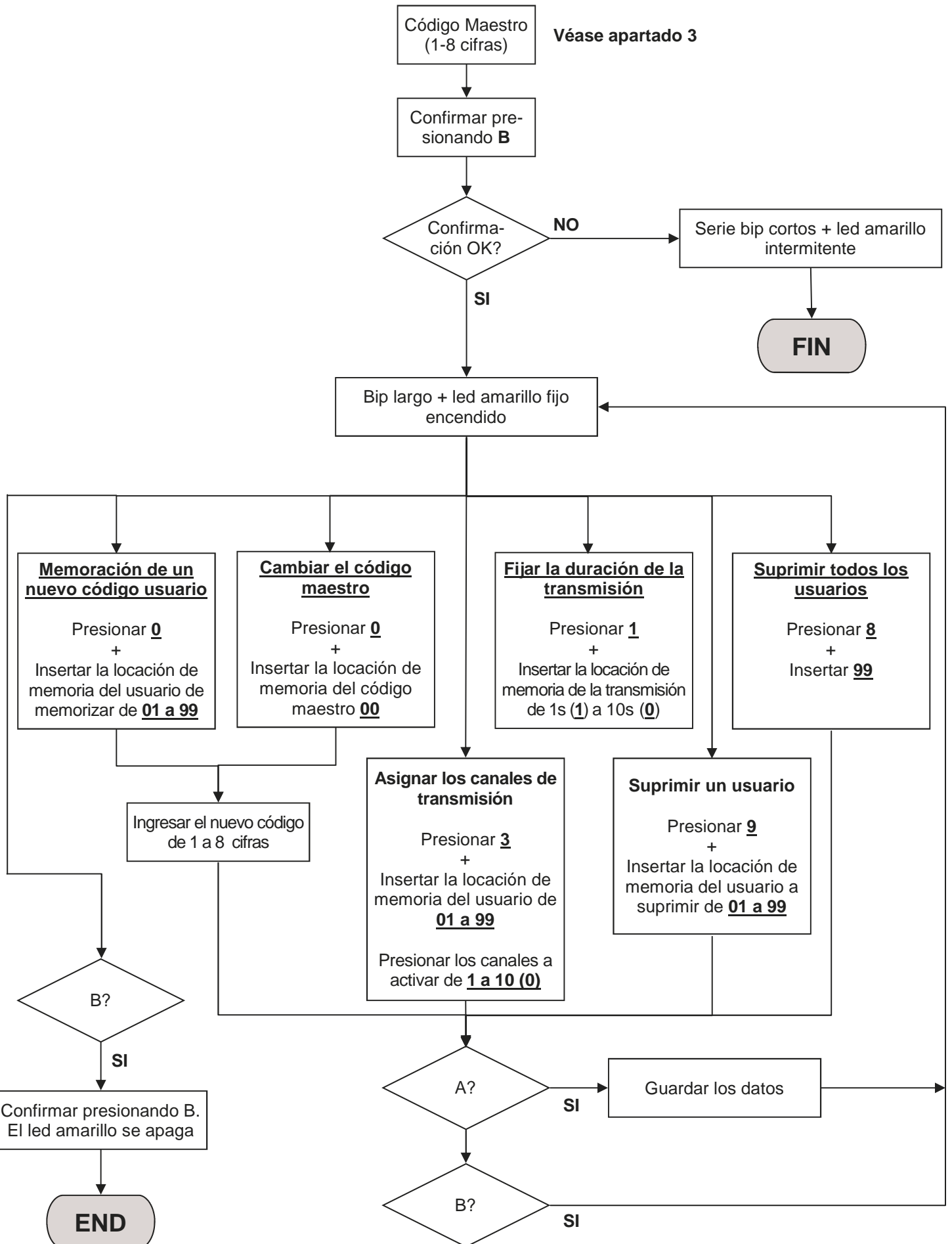

## 11. Configuración DIP-SWITCH

En la parte posterior de la tarjeta hay un DIP-Switch que permite activar/desactivar el buzzer y la retroiluminación del teclado.

**Se sugiere de activar el buzzer durante la configuración.**

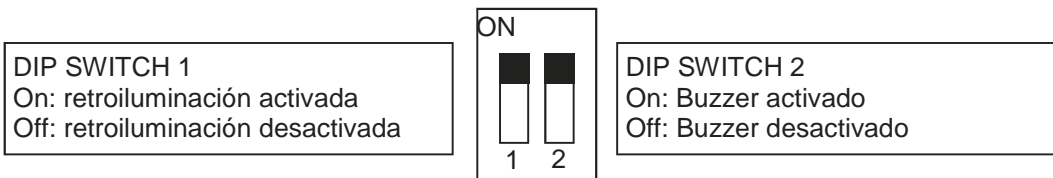

En caso de alimentación con batería, una vez que la programación se ha completado, se sugiere apagar los dos dip-switch con el fin de mejorar la eficiencia y aumentar la vida de la batería.

## 12 Reiniciación total del aparato

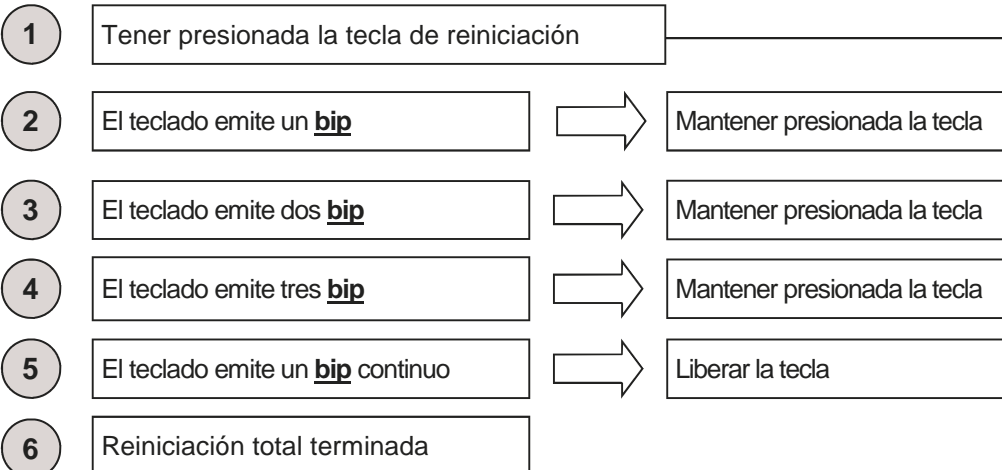

**ATENCIÓN: EN EL CASO DE REINICIACION TOTAL DE TODOS LOS USUARIOS, EL CODIGO MAESTRO (VEASE APARTADO 3) Y TODAS LAS CONFIGURACIONES VUELVEN A SER LAS FIJADA POR LA FABRICA**

### 13 Ejemplo de programación

Este es un ejemplo para programar el dispositivo con el código usuario "123456" activado para poder transmitir en el canal "4" con una duración de transmisión de 6 segundos. El código maestro fijado por la fábrica en este ejemplo es "9876". **Se sugiere modificar el código maestro y fijar un nuevo código.**

#### 1. Cambiar el código maestro

Aquí abajo se puede ver la secuencia para cambiar el código maestro (en este ejemplo es "9876") con el código "456789" (esto código tiene que ser elegido por el cliente, véase apartados 3 y 4)

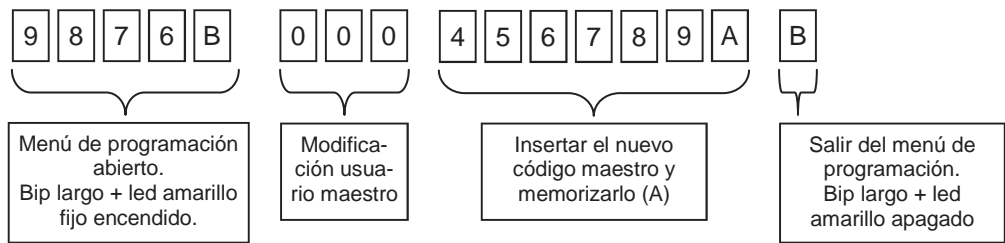

#### 2. Configuración código usuario

Aquí abajo se puede ver la secuencia para crear un nuevo usuario en la locación de memoria "01" con el código de acceso "123456". Véase apartado 5.

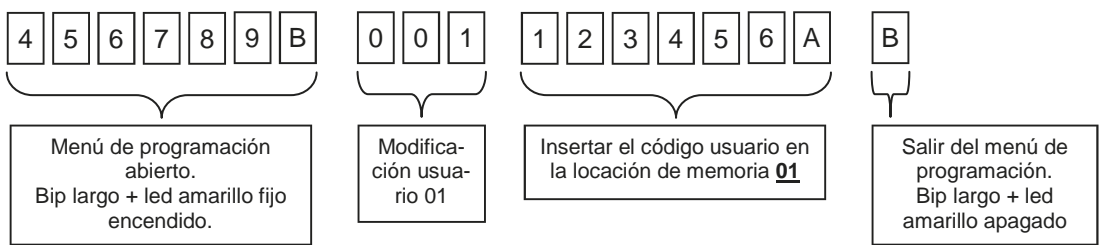

#### 3. Configuración canal de transmisión

Como configuración predeterminada, el dispositivo asigna el canal 1 a cada nuevo usuario. Aquí abajo se ve la secuencia para activar el canal de transmisión "4" para el usuario en la posición de memoria 01. Véase apartado 6.

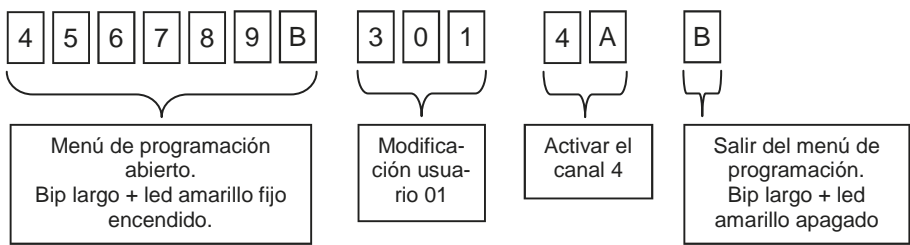

#### 4. Configuración de tiempo de transmisión

Como configuración predeterminada, la duración de la transmisión está fijada en 2 segundos. Aquí abajo hay la secuencia para fijar la duración de la transmisión en 6 segundos para TODOS los canales y TODOS los usuarios. Véase apartado 7.

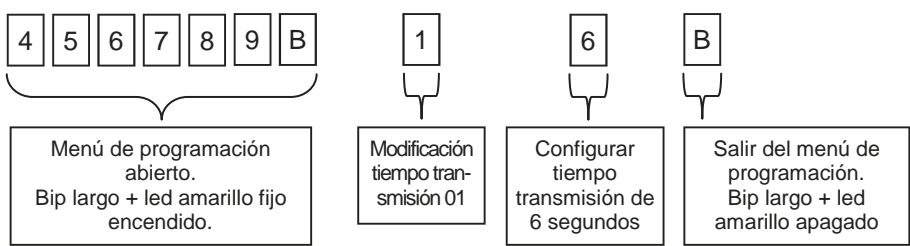

#### 5. Memorización del teclado en el automatismo

Entrar en la modalidad aprendizaje en la central/receptor que se esta usando, insertar el código usuario (ej.123456) en el teclado del RK3, presionar la tecla A y luego presionar la tecla del canal (ej.4) que se desea memorizar.

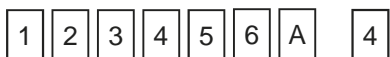

**Registro de usuarios**

Posición de memoria	Código usuario	Nombre	Apellido	Canales activos																
				1	2	3	4	5	6	7	8	9	0							
01																				
02																				
03																				
04																				
05																				
06																				
07																				
08																				
09																				
10																				
11																				
12																				
13																				
14																				
15																				
16																				
17																				
18																				
19																				
20																				
21																				
22																				
23																				
24																				
25																				
26																				
27																				
28																				
29																				
30																				
31																				
32																				
33																				



Posición de memoria	Código usuario	Nombre	Apellido	Canales activos											
				1	2	3	4	5	6	7	8	9	0		
34															
35															
36															
37															
38															
39															
40															
41															
42															
43															
44															
45															
46															
47															
48															
49															
50															
51															
52															
53															
54															
55															
56															
57															
58															
59															
60															
61															
62															
63															
64															
65															
66															

Posición de memoria	Código usuario	Nombre	Apellido	Canales activos											
				1	2	3	4	5	6	7	8	9	0		
67															
68															
69															
70															
71															
72															
73															
74															
75															
76															
77															
78															
79															
80															
81															
82															
83															
84															
85															
86															
87															
88															
89															
90															
91															
92															
93															
94															
95															
96															
97															
98															
99															

GARANTIA - La garantía del fabricante tiene validez en términos legales a partir de la fecha impresa y se limita a la reparación o sustitución gratuita de las piezas reconocidas como defectuosas por falta de cuidados esenciales en los materiales o por defectos de fabricación. La garantía no cubre daños o defectos debidos a agentes externos, defectos de mantenimiento, sobrecarga, desgaste natural, elección inexacta, error de montaje u otras causas no imputables al fabricante. Los productos manipulados no serán objeto de garantía y no serán reparados. Los datos expuestos son meramente indicativos. No podrá imputarse ninguna responsabilidad por reducciones de alcance o disfunciones debidas a interferencias ambientales. La responsabilidad a cargo del fabricante por daños derivados a personas por accidentes de cualquier tipo ocasionados por nuestros productos defectuosos, son solo aquellos derivados inderogablemente de la ley italiana.



ALLMATIC S.r.l.  
32020 Lentiai - Belluno - Italia  
Via dell'Artigiano, n°1 - Z.A.  
Tel. 0437 751175 - 751163 r.a. Fax 0437 751065  
<http://www.allmatic.com> - E-mail: [info@allmatic.com](mailto:info@allmatic.com)